



Multistage Pumps  
with Horizontal Shaft  
*Pompes Multicellulaires  
a Axe Horizontal*  
**Pompe Multistadio  
ad Asse Orizzontale**



**PolyPump Ltd**

Providing your pumping solutions

[sales@polypump.co.uk](mailto:sales@polypump.co.uk)

01296 488 294

**caprari**

pumping power

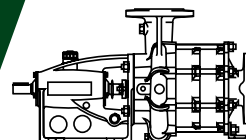

**MEC-MR**

# MEC-MR

**caprari**

pumping power

The MEC-MR series are centrifugal, horizontal, single suction pumps with two or more impellers and fitted with a heavy duty pedestal which gives to the machine the high rigidity necessary for coupling it to combustion engines.

The extended model range of these pumps, the possibility of direct coupling to electric motors or to combustion engines, the availability of special constructions are enabling offers, the best solution for dependability, efficiency and energy saving.

*Les MEC-MR sont des pompes centrifuges à axe horizontal, à aspiration axiale, à deux ou plusieurs étages, montées sur chaise-palier largement dimensionnée, assurant la rigidité indispensable pour l'accouplement aux moteurs à combustion interne.*

*L'étendue de la gamme de production de ces pompes, la possibilité de les accoupler directement à des moteurs électriques et à combustion interne, la disponibilité de constructions spéciales, permettent de proposer, la meilleure solution en tant que fiabilité, rendement et économie d'énergie.*

**Le MEC-MR sono pompe centrifughe ad asse orizzontale, a semplice aspirazione, con due o più giranti dotate di un supporto a sedia ampiamente dimensionato che assicura una grande rigidità alla macchina, indispensabile per l'accoppiamento ai motori termici.**

**L'estensione della gamma di produzione di queste pompe, la possibilità di accoppiamento diretto a motori elettrici e a motori termici, la disponibilità di esecuzioni speciali permettono di proporre, la soluzione ottimale dal punto di vista dell'affidabilità, del rendimento e, conseguentemente, dell'economia di esercizio.**



**CERTIFICATION FOR USE WITH DRINKING WATER: DM174, WRAS, ACS**  
**CERTIFICATION POUR L'EMPLOI EN EAU POTABLE: DM174, WRAS, ACS**  
**CERTIFICAZIONE PER L'IMPIEGO IN ACQUA POTABILE: DM174, WRAS, ACS**

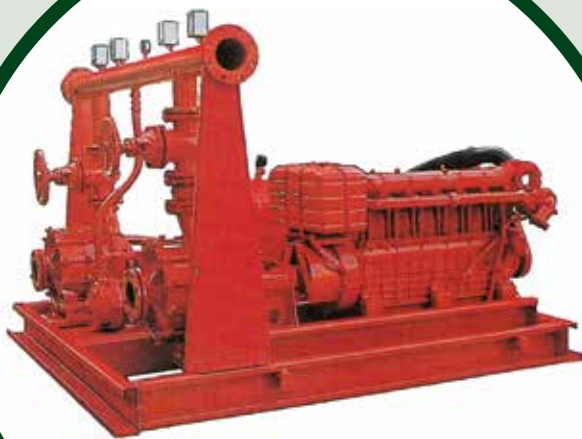

Engine pumping set for fire fighting  
*Groupe motopompe anti-incendie*  
**Gruppo motopompa per servizio antincendio**



Pumping station for frost protection plant  
*Station de pompage pour installation anti-gel*  
**Stazione di pompaggio per l'alimentazione di un impianto antibirina**

- ☐ Every impeller is fitted with two wear rings: simplify maintenance and ensure long life.

*A hauteur de chaque roue sont montées deux bagues d'usure facilement remplaçables : simplifie la maintenance et garantit une longue vie.*

**In corrispondenza di ciascuna girante sono montati due anelli sede, facilmente sostituibili: facilità di manutenzione e prestazioni nel tempo.**

- ☐ The shaft is supported by two ball bearings, oil lubricated, housed inside the pedestal; the shaft of three or more stage pumps is guided also by a support, fitted with a bronze journal bearing, housed in the suction casing having a resting foot: sturdiness and reliability.

*L'arbre pompe est supporté par deux roulements à billes, logés dans le chaise-palier et lubrifiés à l'huile; l'arbre des pompes à plus de deux étages est guidé par un palier supplémentaire en bronze logé dans le couvercle d'aspiration: résistance et fiabilité.*

**L'albero è supportato da due cuscinetti a rotolamento, alloggiati nel supporto e lubrificati ad olio; nelle pompe a tre o più stadi, l'albero è guidato anche da un supporto con bronzina posto nel coperchio di aspirazione dotato di piede di appoggio: robustezza e affidabilità.**

- ☐ The shaft is fitted with an easy replaceable chromed gland packing sleeve: reliability and simplify maintenance.

*A hauteur de la garniture à tresse l'arbre est protégé par une douille chromée facile à remplacer : fiabilité et simplifie la maintenance.*

**In corrispondenza della tenuta a baderna registrabile l'albero è protetto da una bussola facilmente sostituibile: affidabilità e facilità di manutenzione.**



APPLICATIONS  
APPLICATIONS  
APPLICAZIONI

Electric pumping set for a water main  
*Groupe électropompe réalisé pour une adduction d'eau*  
**Gruppo elettropompa per servizio acquedottistico**

- aqueducts
- adduction d'eau*
- acquedottistica**
- water supply
- alimentation d'eau potable*
- alimentazione idrica ad uso civile**
- conditioning
- conditionnement*
- condizionamento**
- industrial applications
- installations industrielles*
- applicazioni industriali**
- fire-fighting
- lutte anti-incendie*
- antincendio**
- leisure parks
- equipements pour les loisirs*
- impianti per il tempo libero**
- irrigation
- irrigation*
- irrigazione**

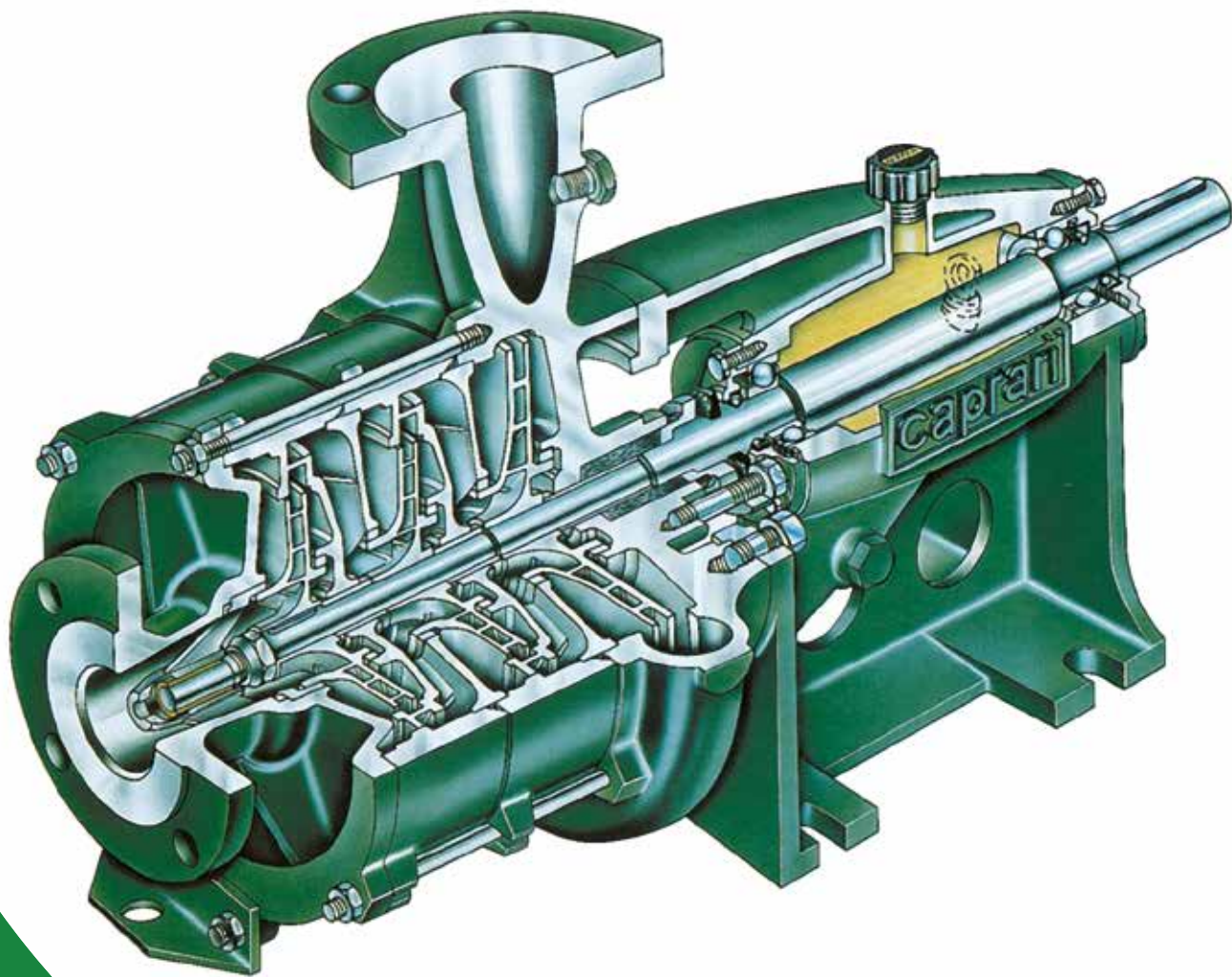

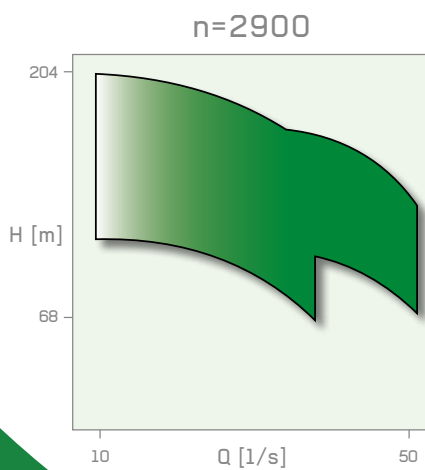
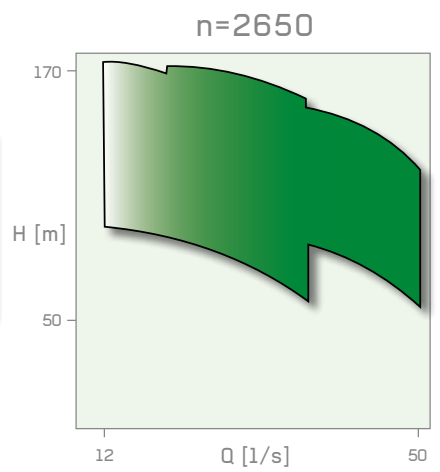
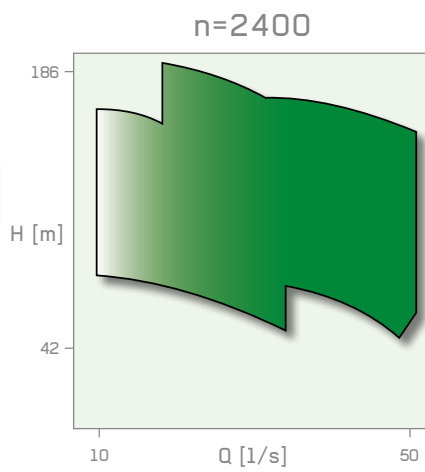
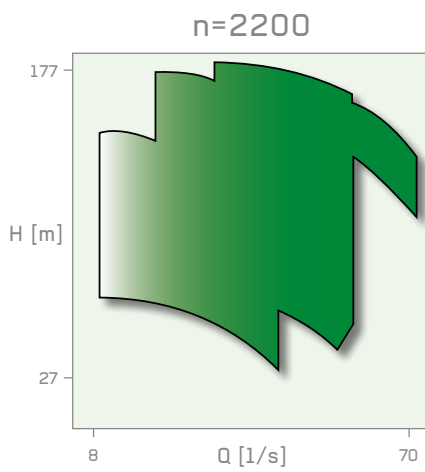
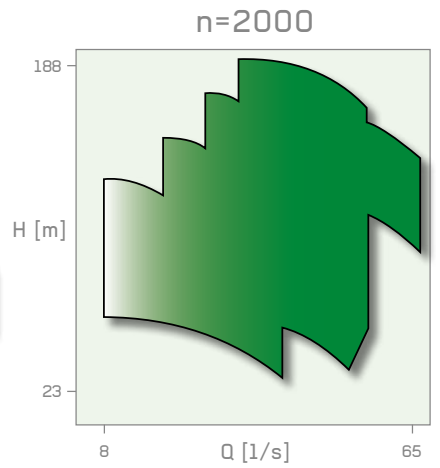
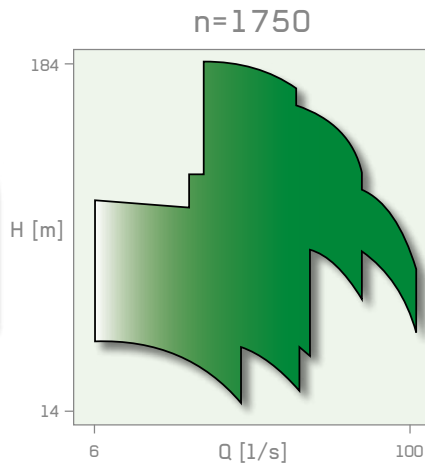
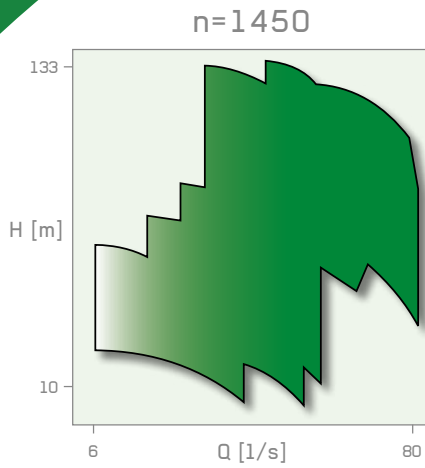

Executions on demand  
 Exécutions sur demande  
 Esecuzioni a richiesta

Discharge size positioning  
 Orientations orifice de refoulement  
**Orientamento bocca**

With bronze impellers  
 Avec roues en bronze  
**Giranti in bronzo**

With mechanical seal (only for two stage types)  
 Avec garniture mécanique  
 (seulement pour pompes à deux étages)  
**Con tenuta meccanica (solo per pompe a due stadi)**

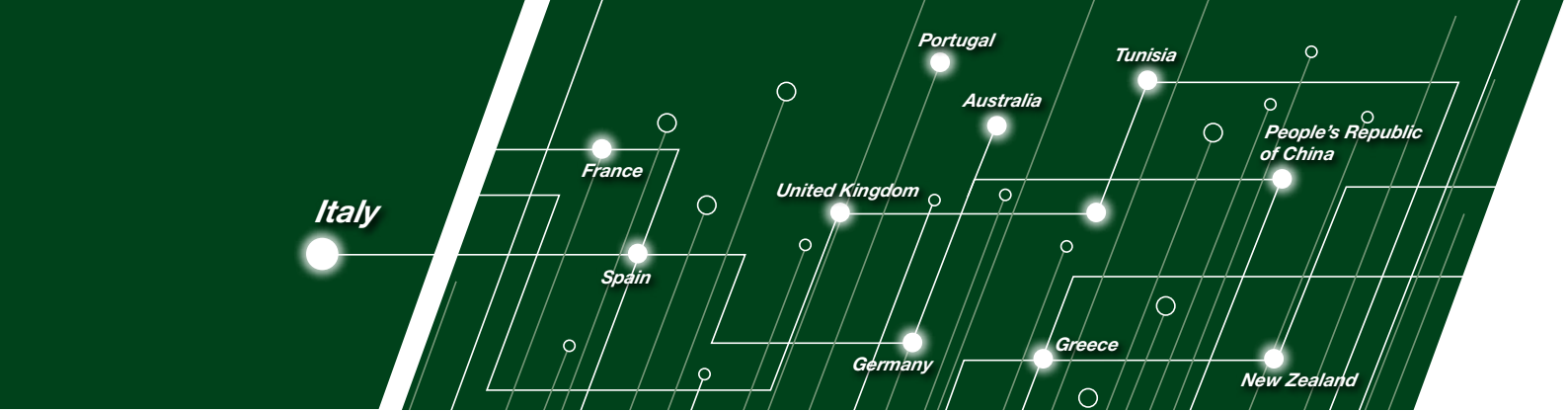

**CAPRARI SPA** Modena (Italy) • **CAPRARI FRANCE SARL** Maurepas - Paris (France) • **BOMBAS CAPRARI SA** Alcalá de Henares Madrid (Spain) • **CAPRARI PUMPS (U.K.) LTD** Peterborough (United Kingdom) • **CAPRARI PUMPEN GMBH** Fürth/Bayern (Germany) • **CAPRARI PORTUGAL LDA** Santarém (Portugal) • **CAPRARI PUMPS AUSTRALIA PTY LTD** Beverley SA (Australia) • **CAPRARI HELLAS SA** Thessaloniki (Greece) • **CAPRARI TUNISIE SA** Ben Arous (Tunisia) • **CAPRARI PUMPS (SHANGHAI) CO LTD** Shanghai (People's Republic of China) • **CAPRARI PUMPS NEW ZEALAND** Christchurch (New Zealand)



**Water Collection and Distribution**



**Boosting and Distribution of surface water**



**Wastewater Transport and Treatment**



**Pump Control Technology**

**caprari**  
pumping power



[www.caprari.com](http://www.caprari.com)