

JUNG PUMPEN U5K DRAINAGE PUMPS



U 5 KS with built-in level control

APPLICATION

The U 5 K (S) is an extremely powerful and versatile centrifugal submersible pump for both stationary and portable use. The pump is suitable for faecal-free wastewater with solids up to 10 mm particle size. Thanks to the removable strainer base, it is possible to increase the free passage to 20 mm.

Stationary in a basement chamber or a collecting tank, with an automatic switch attached, the U 5 KS handles all dirty water arising from domestic drainage sources such as washing machines, dish-washers, washstands, etc. Deposit accumulation in the reservoirs and chambers is reduced to a minimum by means of a flushing device.

The guide rail system GR 32 offers all the advantages of fast and easy maintenance. If the sump or tank runs dry temporarily, the pump can be vented by providing a drill-hole in the spiral housing.

The U 5 K can be used as a portable unit for dealing with dirty water from garden ponds, flooded cellars or discharge chambers in laundry rooms or storage rooms. Thanks to its shallow, built-in suction system, it can reduce residual water level to no more than a few millimeters.

If submersible pumps are used outdoors, only a pump with 10 m cable without extension cable may be used in accordance with VDE Regulation 0100. For construction sites and garden ponds, a H07-type cable must be used.

- Continuous operation
- Low level pumping
- Flushing device
- Built-in level control
- Variable discharge branch
- Safe to run dry
- 10/20 mm free passage with EIP technology
- Swing-type check valve for portable use
- Moisture sealed cable inlet

PERFORMANCE

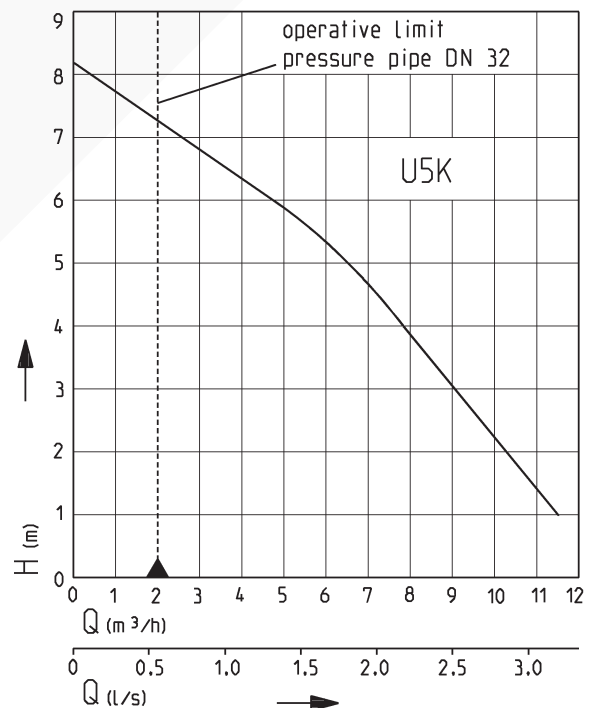

40895-01

We reserve the right to change specifications without notice

Pump performance is subject to ISO 9906 tolerances

The minimum flow velocity in the pressure piping must be 0.7 m/s according to EN 12056. This data is represented in the performance curve as a limit of application.

JUNG PUMPEN U5K

DRAINAGE PUMPS

DRAINAGE PUMPS

Type		Maximum Height x Width x Depth	Discharge branch	Free passage	Cable quality	Cable length	Weight approx.	Code No.
Pump without level control (not to be utilised on construction sites, as per VDE regulations)								
U5K	without bend	280 x 168 x 190 mm	1 1/4"	20 mm	H05RN-F-3G0.75	10 m	4.7 kg	JP09386
	with bend	280 x 168 x 250 mm						
Pumps with built-in level control								
U5KS	(acc. to VDE, not to be used outdoors)	280 x 202 x 290 mm	1 1/4"	20 mm	H05RN-F-3G0.75	4 m	4.5 kg	JP09387
U5KS		280 x 202 x 290 mm	1 1/4"	20 mm	H07RN-F-3G1.00	10 m	5.4 kg	JP09417

PERFORMANCE

Type	Delivery head H [m]	1	2	3	4	5	6	7
U5K	Flow rate Q [m³/h]	11.5	10.5	9	7.5	6.5	4.5	2.5

ELECTRICAL DATA

Type	Type of current	Voltage Volt	Motor rating kW		RPM min ⁻¹	Current Ampere	Motor protection	Plug
			P ₁	P ₂				
U5K	W-Current	1/N/PE~230	0.52	0.38	2716	2.3	integrated	Safety-

Example of single pump installation with GR

Single unit with built-in level control
 Sump area with GR 32 min. 40 x 50 cm, Ø 50 cm
 Sump area without GR min. 40 x 40 cm, Ø 40 cm (without ill.)

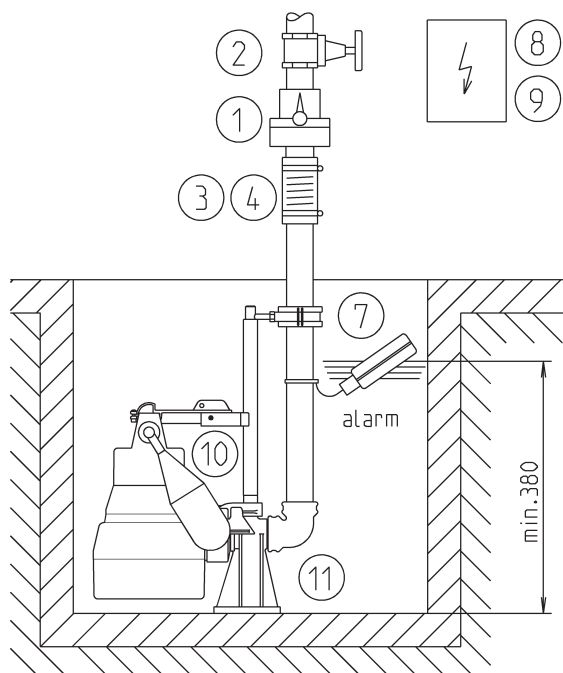

40522-02

In case of installation beneath the backpressure level the pressure tube must be taken in a loop over the local backup level acc. to EN 12056. Besides, it must be secured with a EN 12050-4-proofed swing-type check valve. Besides, it must be secured with an EN 12050-4-proofed swing-type check valve. Additionally we recommend an alarm system.

Example of duplex pump installation

Duplex unit with control unit
 Sump area with GR 32 min. 50 x 50 cm, Ø 60 cm (without ill.)
 Sump area without GR min. 45 x 50 cm, Ø 55 cm

Suspend control unit in a dry room.

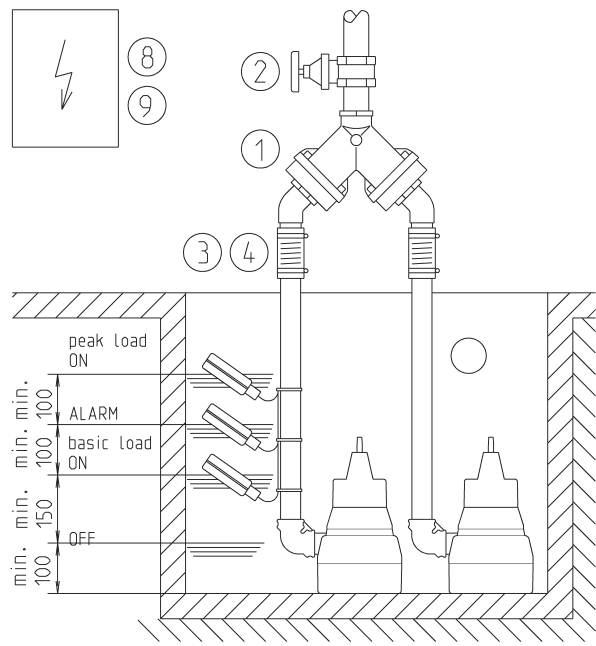

↑ Notice of min. distance !











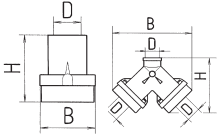
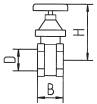

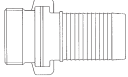
40521-01

In accordance with DIN EN 12056-4 Abs. 5.1, it has a built-in automatic spare pump or a double attachment included, which ensures that sewage drainage is not interrupted.

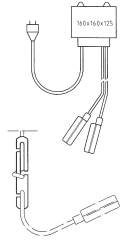
JUNG PUMPEN U5K

DRAINAGE PUMPS

ACCESSORIES

				Code No.	U5K	U5KS
	1 Swing-type check valve 1¼" (DN 32), PN 4 DIN EN 12050-4	$\frac{H}{90}$ $\frac{W}{90}$ $\frac{D}{1\frac{1}{4}"}$		JP09739	•	•
	Duplex swing-type check valve 1½" (DN 40), PN 4 for duplex pump station DIN EN 12050-4	$\frac{H}{200}$ $\frac{W}{280}$ $\frac{D}{1\frac{1}{2}"}$		JP09155	•	
	2 Stop valve 1¼" (DN 32), PN 16	$\frac{H}{110}$ $\frac{W}{\text{max. } 60}$ $\frac{D}{1\frac{1}{4}"}$		JP44785	•	•
	1½" (DN 40), PN 16	125 max. 60 1½"		JP44786	•	
	3 Elastic connection 1¼" (DN 32), PN 3	$\frac{H}{100}$ $\frac{D}{42}$		JP44773	•	•
	4 Hose band clamp 1¼"			JP44765	•	•
 	5 Hose coupling 1¼" (DN 32) brass, for portable use			JP00327	•	•
	Solid fire hose coupling 1 ¼", male thread			JP44780	•	•
	Coupling wrench			JP25708	•	•
	Hose connection 1 ¼" - 38/32/25			JP44209	•	•
	6 Hose set, 15 m PVC hose c/w elbow			JP43550	•	•
	7 Alarm unit AG3 with submersible ball contact switch, separate, mains-dependent, with potential free contact and 3 m cable			JP44891		•
	Alarm unit AG10 ditto, with 9.5 m cable			JP44892		•
	Alarm unit washing machine stop AW3 with submersible ball contact switch with 3 m cable, separate, mains-dependent			JP44895	•	•
	8 Separate level controls for single unit (see level controls for description)					
	NE 1 with sub. ball contact switch 3,0 m			JP16710	•	
	NE 2 with sub. ball contact switch 9.5 m			JP16711	•	
	NE 1A with sub. ball contact switch 3.0 m and alarm system			JP16714	•	
	NE 2A with sub. ball contact switch 9.5 m and alarm system			JP16715	•	
	Counterweight (1 piece)			JP44803	•	
	Duplex control unit (see section on level controls for description)					
BD 00E			JP45735	•		
Subm. switch pack B with 3 subm. ball contact switches with 9.5 m cable and fixing device			JP16725	•		
Subm. switch pack BmG with 3 subm. ball contact switches with 9.5 m cable and counterweight			JP16726	•		
	9 Rechargeable battery for off the line operation of the alarm system			JP44850	•	•
	10 Special float assembly for low switching points (Switching height without GR ON 90 mm, OFF 40 mm)			JP44207		•
	Special float assembly for narrow chambers (chamber min. 30x30 cm) Switching height without GR ON 265 mm, OFF 195 mm			JP40856		•
	Float fixation for continuous pump operation			JP42175		•
	11 Guide rail system GR 32			JP44000	•	•
	Support for guide rail extension ex 2 m sump depth, per m 1 piece			JP28314	•	•
	12 Connection kid DN 32 with telescopable pressure pipe			JP44609	•	•

