

JUNG PUMPEN US 75-155

SUBMERSIBLE DRAINAGE PUMPS

50 MM FREE PASSAGE

APPLICATION

The centrifugal submersible drainage pumps US 75-155 are suitable for dealing with notably contaminated water and capable of handling solids up to 50 mm particle size. With their free passage of 50 mm, these pumps are able to pump solids and fibers quickly, reliably and above all without blockage!

For easy removal of the pumps from deep sumps we recommend the use of our guide rail systems which provide ease of maintenance and inspection. A controllable oil chamber and wear-resistant special mechanical seal ensure a long service life. The integrated winding thermostats protect the motor from overload.

For automatic monitoring of the oil chamber a seal leak control can be connected.

Maximum cable length is 10 m. The US 155 DS 3-phase pump with level control has a CEE-Plug with phase inverter.

The sewage pumps are tested by the German Institute for Construction Engineering and correspond to the valid construction and test principles.



US 105 ES

- Safe to run dry
- Easy to maintain due to guide rail systems
- 50 mm free passage
- Controllable oil chamber
- SiC mechanical seal independent of rotation direction
- Replaceable moisture sealed cable inlet

PERFORMANCE

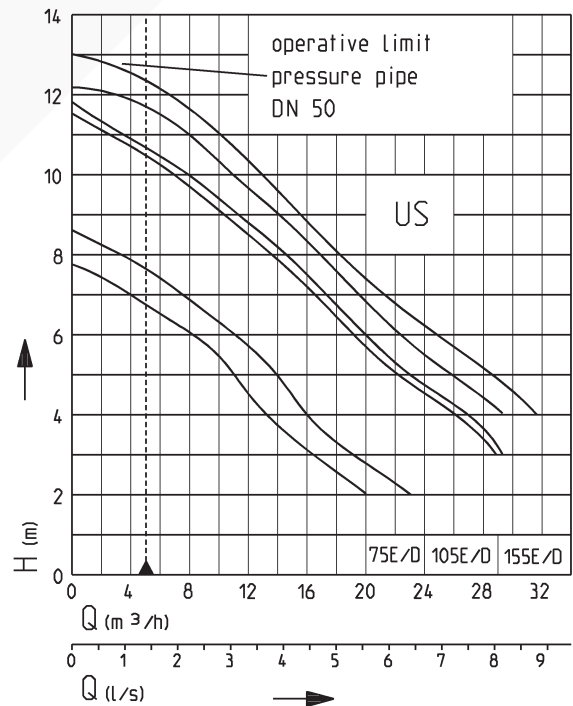

We reserve the right to change specifications without notice

Pump performance is subject to ISO 9906 tolerances

The minimum flow velocity in the pressure piping must be 0.7 m/s according to EN 12056.

This data is represented in the performance curve as a limit of application.

JUNG PUMPEN US 75–155

SUBMERSIBLE DRAINAGE PUMPS

50 MM FREE PASSAGE

SUBMERSIBLE DRAINAGE PUMPS US 75–155

Type	Maximum Height x Width x Depth	Discharge branch	Free passage	Cable quality H07RN-F-	Cable length	Weight approx.	Code No.
US 75 E	395 x 200 x 230 mm	2"	50 mm	3G1,0	10 m	13,0 kg	JP09406
US 75 D	395 x 200 x 230 mm	2"	50 mm	4G1,0	10 m	13,1 kg	JP09404
US 105 E	425 x 200 x 230 mm	2"	50 mm	3G1,0	10 m	14,5 kg	JP09410
US 105 D	425 x 200 x 230 mm	2"	50 mm	4G1,0	10 m	15,1 kg	JP09408
US 155 E*	450 x 200 x 230 mm	2"	50 mm	3G1,0	10 m	16,0 kg	JP09388
US 155 D*	450 x 200 x 230 mm	2"	50 mm	4G1,0	10 m	16,5 kg	JP09390
Pumps with built-in level control							
US 75 ES	395 x 240 x 335 mm	2"	50 mm	3G1,0	10 m	13,0 kg	JP09407
US 75 DS	395 x 240 x 335 mm	2"	50 mm	4G1,0	10 m	13,2 kg	JP09405
US 105 ES	425 x 238 x 335 mm	2"	50 mm	3G1,0	10 m	14,6 kg	JP09411
US 105 DS	425 x 238 x 335 mm	2"	50 mm	4G1,0	10 m	15,2 kg	JP09409
US 155 ES	450 x 240 x 335 mm	2"	50 mm	3G1,0	10 m	16,3 kg	JP09389
US 155 DS**	450 x 240 x 335 mm	2"	50 mm	4G1,0	10 m	17,2 kg	JP09391

* without plug ** CEE-Motorprotection with phase inverter

PERFORMANCE

Type	Delivery head H [m]	2	3	4	5	6	7	8	9	10	11	12
US 75 E/ES	Flow rate Q [m³/h]	20	16	13	10	7	4					
US 75 D/DS		23	19	16	12	10	7	3				
US 105 E/ES			28	25	22	19	16	13	10	7	3	
US 105 D/DS			29	26	23	20	17	14	11	8	4	
US 155 E/ES				29	26	22	20	16	14	11	8	2
US 155 D/DS				31	28	25	21	19	16	13	10	6

ELECTRICAL DATA

Type	Type of current	Voltage Volt	Motor rating kW		RPM min-1	Current Ampere	Motor protection	Plug
			P1	P2				
US 75 E/ES	1-phase	1/N/PE~230	0,83	0,50	2510	3,9	integrated	Safety-
US 75 D/DS	3-phase	3/PE~400	0,85	0,60	2800	1,4	integrated	CEE-
US 105 E/ES	1-phase	1/N/PE~230	1,37	0,98	2700	6,0	integrated	Safety-
US 105 D/DS	3-phase	3/PE~400	1,36	1,06	2740	2,4	integrated	CEE-
US 155 E	1-phase	1/N/PE~230	1,60	1,21	2814	7,5	on site*	-
US 155 ES	1-phase	1/N/PE~230	1,60	1,21	2814	7,5	integrated	Safety-**
US 155 D	3-phase	3/PE~400	1,70	1,41	2815	3,1	on site*	-
US 155 DS	3-phase	3/PE~400	1,70	1,41	2815	3,1	integrated	CEE-**

* additional requirements, see technical data or accessories

** Protective motor plug

JUNG PUMPEN US 75-155

SUBMERSIBLE DRAINAGE PUMPS

50 MM FREE PASSAGE

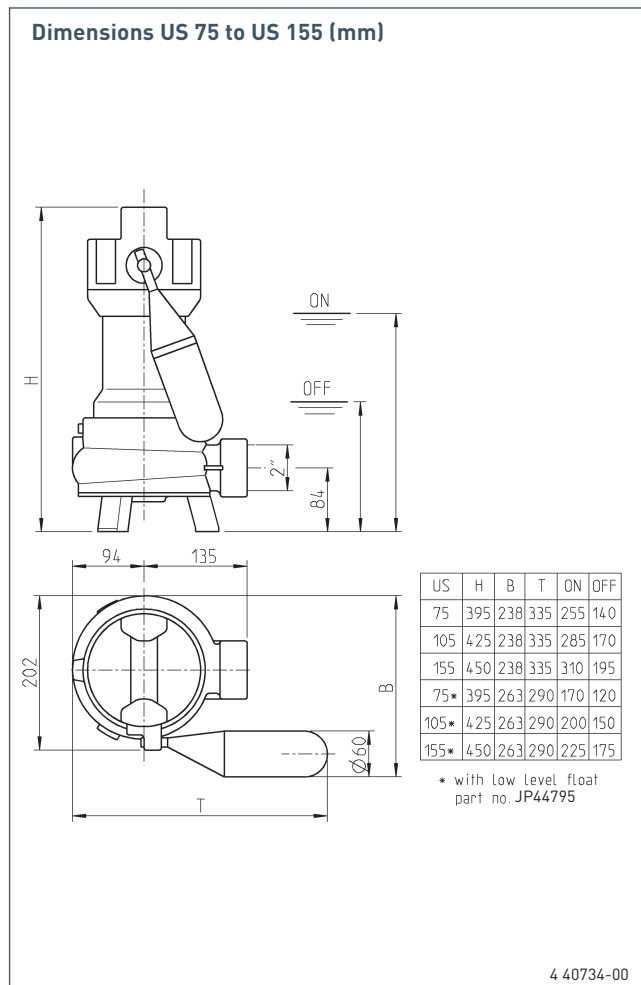
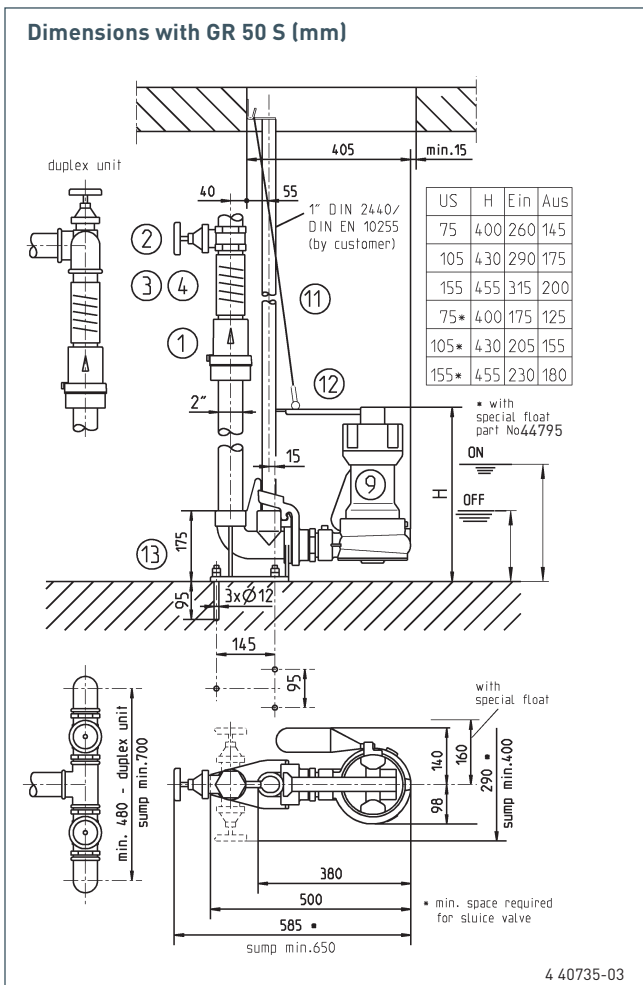









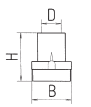
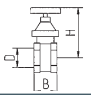

JUNG PUMPEN US 75-155

SUBMERSIBLE DRAINAGE PUMPS

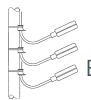
50 MM FREE PASSAGE

ACCESSORIES

				Code No.	75 E	75 ES	75 D	75 DS
Pump without plug (for connection to duplex control unit)								
	1	Swing-type check valve DIN EN 12050-4	2" (DN 50), PN 4	H W D 150 120 2"	JP00326	•	•	•
		Ball check valve DIN EN 12050-4	2" (DN 50), PN 6	185 155 2"	JP44782	•	•	•
	2	Stop valve	2" (DN 50), PN 16	H W D 140 max. 67 2"	JP44787	•	•	•
	3	Elastic connection	2" (DN 50), PN 4	H D 150 63	JP44775	•	•	•
	4	Hose band clamp	2"		JP44764	•	•	•
	5	Elbow 2"			JP44771	•	•	•
	6	Alarm unit AG3 with submersible ball contact switch, separate, mains-dependent, with potential-free contact and 3 m cable			JP44891		•	•
		Alarm unit AG10 ditto, with 9.5 m cable			JP44892		•	•
		Alarm unit washing machine stop AW3 with submersible ball contact switch with 3 m cable, separate, mains-dependent			JP44895	•	•	•
	7	Separate level controls for single unit (see NE level controls for description)						
		NE 1 (1-phase current) with sub. ball contact switch 3.0 m			JP16710	•		
		NE 2 (1-phase current) with sub. ball contact switch 9.5 m			JP16711	•		
		ND 1 (3-phase current) with sub. ball contact switch 3.0 m			JP16712		•	
		ND 3 (3-phase current) with sub. ball contact switch 9.5 m			JP16713		•	
		NE 1A (1-phase current) with sub. ball contact switch 3.0 m and alarm system			JP16714	•		
		NE 2A (1-phase current) with sub. ball contact switch 9.5 m and alarm system			JP16715	•		
		ND 1A (3-phase current) with sub. ball contact switch 3.0 m and alarm system			JP16716		•	
		ND 3A (3-phase current) with sub. ball contact switch 9.5 m and alarm system			JP16717		•	
		Counterweight (1 piece)			JP44803	•	•	
		Duplex control units (see section on level controls for description)						
		BD 00 E (1-phase current)			JP45735	•		
		BD 00 (3-phase current)			JP45993		•	
		BD 25 (3-phase current)			JP45737			
		Subm. switch pack B with 3 subm. ball contact switches w. 9.5 m cable a. fixing devices			JP16725	•	•	
		BmG with 3 subm. ball contact switches with 9.5 m cable and counterweight			JP16726	•	•	
		Protective motor plug- 8 A, 230 V (without level control)			JP44753			
	Protective motor plug- 2.5-4 A, 400 V (without level control)			JP44754				
	8	Rechargeable battery for off the line operation of the alarm system			JP44850	•	•	•
	9	Seal leak detector DKG			JP44900	•	•	•
	10	Special float assembly for low switching points *						
		Switching points US 75 ON/OFF US 105 ON/OFF US 155 ON/OFF			JP44795		•	•
		without GR 170/120 mm 200/150 mm 225/175 mm						
	with GR 175/125 mm 205/155 mm 230/180 mm							
	11	Chain certified, stainless steel, 2.5 m, 5 rings, 160 kg, (EN 818 mod.)			JP45901	•	•	•
		Chain certified, stainless steel, 5.0 m, 8 rings, 160 kg, (EN 818 mod.)			JP45902	•	•	•
	12	Webbing with shackle A 0.6			JP45168	•	•	•
	13	Guide rail system GR 50 S			JP40740	•	•	•
		Foot strainer , 10 mm free passage			JP25135	•	•	•
		Pump pedestal stainless steel, 50 mm free passage			JP40632	•	•	•

* only for single units ♦ only in connection with a motor protection plug ✕ Control unit on request

JUNG PUMPEN US 75–155

SUBMERSIBLE DRAINAGE PUMPS

50 MM FREE PASSAGE

TECHNICAL DATA

Pump

Vertical, single stage, submersible, open centrifugal impeller, spiral housing with free inlet. Free passage 50 mm, horizontal discharge branch with 2" female thread.

Bearings

Common shaft for pump and motor, with ball bearings, deep groove ball bearing with grease chamber.

Seal

Silicon carbide mechanical seal, oil chamber and duplex rotary seal towards the motor section, safe to run dry, a seal leak control can be connected.

Motor

Submersible, motor type of enclosure IP 68, insulation class B, winding thermostat protects the motor from overload, starting via plug, automatically via mounted circuit or submersible ball contact switches.

US 155: To protect the motor, a correct adjusted motor protecting switch has to be provided in the control unit at site by the customer.

Material

Spiral housing made of GG grey cast iron, power supply through rubber insulated flexible cable.

Terminal board lid, vortex impeller and wear plate made of GRP, motor casing and shaft in stainless steel.

Installation

Pump can be installed free standing or in connection with guide rail system GR 50 S install.

Scope of supply

Pump according to DIN EN 12050 ready for connection with 10 m cable. Foot strainer made of GRP enclosed.

US 155: Pumps without level control with free lead end. Pump with level control with CEE-Plug and phase inverter (3-phase) or safety-plug (1-phase).

