



DRY INSTALLED SEWAGE ELECTRIC PUMPS
*ELECTROPOMPES POUR EAUX CHARGEES
EN FOSSE SECHE*
ELETTOPOMPE PER ACQUE REFLUE IN
CAMERA ASCIUTTA

K-Kompact

50 Hz *non stop* **K+**



PolyPump Ltd

Providing your pumping solutions

sales@polypump.co.uk

01296 488 294

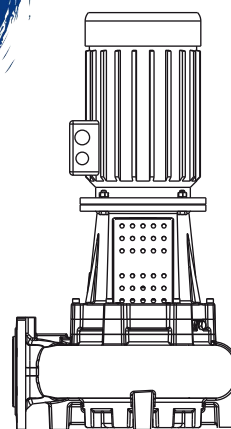

caprari

pumping power



ISO 9001= ISO 14001

OHSAS 18001

Introduction; <i>Présentation</i> ; Presentazione	3
Uses - Performances range; <i>Domaine d'emploi - Champs des performances</i> ; Impieghi - Campo di prestazioni	4
Mechanical features; <i>Caractéristiques mécaniques</i> ; Caratteristiche meccaniche ;	5
Hydraulic specifications; <i>Caractéristiques hydrauliques</i> ; Tipologie idrauliche	6
Possible installations; <i>Versions possibles</i> ; Installazioni possibili	7
Technical and operational features; <i>Caractéristiques techniques et de fonctionnement</i> ; Caratteristiche tecniche e di funzionamento	8

DN 80÷100

KKCW080H - KKCM080H - KKW100H - KKCM100H

Performances range; <i>Champs des performances</i> ; Campo di prestazioni	9
Electric pump coding; <i>Exemplification du sigle de l'électropompe</i> : Esemplificazione sigla elettropompa	10
Construction and materials; <i>Construction et matériaux</i> ; Costruzione e materiali	11
Technical features, dimensions and weights; <i>Caractéristiques de fonctionnement, dimensions et poids</i> ; Caratteristiche di funzionamento, dimensioni e pesi ;	13
Accessories; <i>Accessoires</i> ; Accessori	29

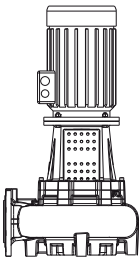

DN 80÷200

KKCW080L - KKCM080L - KKW100L - KKCM150L - KKCM150H - KKCD200N

Performances range; <i>Champs des performances</i> ; Campo di prestazioni	31
Electric pump coding; <i>Exemplification du sigle de l'électropompe</i> : Esemplificazione sigla elettropompa	32
Construction and materials; <i>Construction et matériaux</i> ; Costruzione e materiali	33
Technical features, dimensions and weights; <i>Caractéristiques de fonctionnement, dimensions et poids</i> ; Caratteristiche di funzionamento, dimensioni e pesi	35
Accessories; <i>Accessoires</i> ; Accessori	53

DN 100÷250

KKCW100N - KKCM100N - KKCM150N - KKCM200P - KKCD200N - KKCD250P

Performances range; <i>Champs des performances</i> ; Campo di prestazioni	55
Electric pump coding; <i>Exemplification du sigle de l'électropompe</i> : Esemplificazione sigla elettropompa	56
Construction and materials; <i>Construction et matériaux</i> ; Costruzione e materiali	57
Technical features, dimensions and weights; <i>Caractéristiques de fonctionnement, dimensions et poids</i> ; Caratteristiche di funzionamento, dimensioni e pesi	59
Accessories; <i>Accessoires</i> ; Accessori	73

Flanges (UNI EN 1092-2) - <i>Brides (UNI EN 1092-2)</i> - Flange (UNI EN 1092-2)	74
---	----

The K-Kompact series of electric pumps are designed to handle residential and industrial waste waters using the very latest technology.

The product features the compactness found in monobloc pumps, vibration-free operation, a smaller size and the versatility found in pumps connected with an elastic joint.

K-Kompact pumps deliver excellent efficiency in single and double channel impeller configurations. The open retracted version is especially suitable for use with liquids containing high concentrations of solid particles, long fibres and dissolved gases. They are designed both for horizontal installation, with painted steel support, and for vertical installation, on a galvanized steel base frame, for minimal base dimensions.

The main area of application for these pumps lies in water purification and treatment. In particular they can be used in denitrification, nitrification, slurry recirculation, and filter washing, and in industrial installations in general, especially in the textile, paper, steel, tanning, food, ceramic and marble industries.

La série d'électropompes K-Kompact est conçue pour traiter les eaux usées privées et industrielles, en utilisant la technologie la plus avancée.

Les particularités de ce produit sont la compacité caractéristique des pompes monobloc, l'absence de vibrations, l'encombrement réduit et la souplesse semblable à celle des pompes assemblées au moyen d'un joint élastique.

Les pompes ont un rendement élevé tant avec turbine mono qu'à 2 canaux; la version vortex est particulièrement appropriée aux liquides contenant des concentrations élevées de substances solides, fibres longues et gaz en solution.

Elles sont prévues tant pour les installations horizontales, avec support en acier peint, que pour les installations verticales, sur châssis de soutien en acier galvanisé, pour un encombrement minimum.

Les principaux secteurs d'emploi sont l'épuration et le traitement des eaux : phases de dénitrification, nitrification, circulation boues, lavage filtres et l'industrie, plus spécialement les secteurs textile, papetier, sidérurgique, de la tannerie, alimentaire, céramique et l'industrie du marbre.

La serie di elettropompe K-Kompact sono progettate per trattare acque reflue civili e industriali, utilizzando la tecnologia più avanzata.

Le peculiarità del prodotto sono la compattezza caratteristica delle pompe monoblocco, l'assenza di vibrazioni, il ridotto ingombro e la flessibilità come nelle pompe accoppiate per mezzo di giunto elastico.

Le pompe hanno alto rendimento sia con girante mono che bicanale; la versione a vortice arretrato è particolarmente adatta per liquidi contenenti alte concentrazioni di sostanze solide, fibre lunghe e gas in soluzione.

Sono previste sia per installazione orizzontale, con supporto di sostegno in acciaio verniciato, sia per installazione verticale, su telaio di sostegno in acciaio zincato, per un minimo ingombro in pianta.

I principali settori di utilizzo sono la depurazione e il trattamento delle acque: fasi di denitrificazione, nitrificazione, ricircolo fanghi, lavaggio filtri e l'industria, più specificatamente il settore tessile, cartario, siderurgico, conciario, alimentare, ceramico, e l'industria del marmo.

Uses
Domaine d'emploi
Impieghi

Thanks to their tough construction, series K-Kompact electric pumps can be used to pump a variety of fluids amongst which are:

- untreated water
- rain water
- mixed water
- sewage with solids and fibres
- activated sludges
- the recirculated sludges of digesters
- industrial sludge
- dirty abrasive water
- clean and drinking water.

The permissible percentage of dry matter and the size and nature of the solids, the degree of aggressiveness and/or abrasiveness of the water are parameters often bound to the particular pump hydraulics or the physical dimensions.

A sewage pump must therefore be chosen according to the hydraulics and constructional features and materials of the pump itself.

Always consult our technicians for heavy duty uses or use beyond the specifications indicated in this catalogue.

Les électropompes K-Kompact, grâce à leur construction solide, peuvent être utilisées pour le relevage de différents liquides et en particulier:

- eaux brutes
- eaux pluviales
- eaux mixtes
- eaux résiduaires avec des corps solides et fibres
- boues activées
- boues de circulation des digesteurs
- boues industrielles
- eaux chargées abrasives
- eaux claires et potables.

Le pourcentage de matière sèche admissible, de même que la dimension et la nature des solides et le degré d'agressivité ou d'abrasion des eaux sont des paramètres liés au système hydraulique de la pompe et à son dimensionnement.

Il faut donc choisir une électropompe pour le relevage de liquide

chargé en fonction des caractéristiques hydrauliques et des matériaux de construction.

Pour des emplois particuliers, hors des spécifications indiquées dans ce catalogue, veuillez consulter directement nos techniciens.

Le elettropompe K-Kompact per la loro solida costruzione possono essere impiegate nel sollevamento di diversi liquidi fra i quali:

- acque grezze
- acque piovane
- acque miste
- acque nere con solidi e fibre
- fanghi attivi
- fanghi di ricircolo dei digestori
- fanghi industriali
- acque cariche abrasive
- acque pulite potabili.

La percentuale di sostanza secca ammissibile, così come la dimensione e la natura dei solidi, il grado di aggressività e/o di abrasività delle acque, sono parametri spesso legati alla particolare idraulica della pompa o alle sue caratteristiche dimensionali.

La scelta di una elettropompa per il sollevamento di un liquido carico deve essere quindi fatta in base alle caratteristiche dell'idraulica e dei materiali costruttivi della pompa.

Per impieghi gravosi o comunque al di fuori delle specifiche date in questo catalogo consultare i nostri tecnici.

Performances range
Champs des performances
Campo di prestazioni

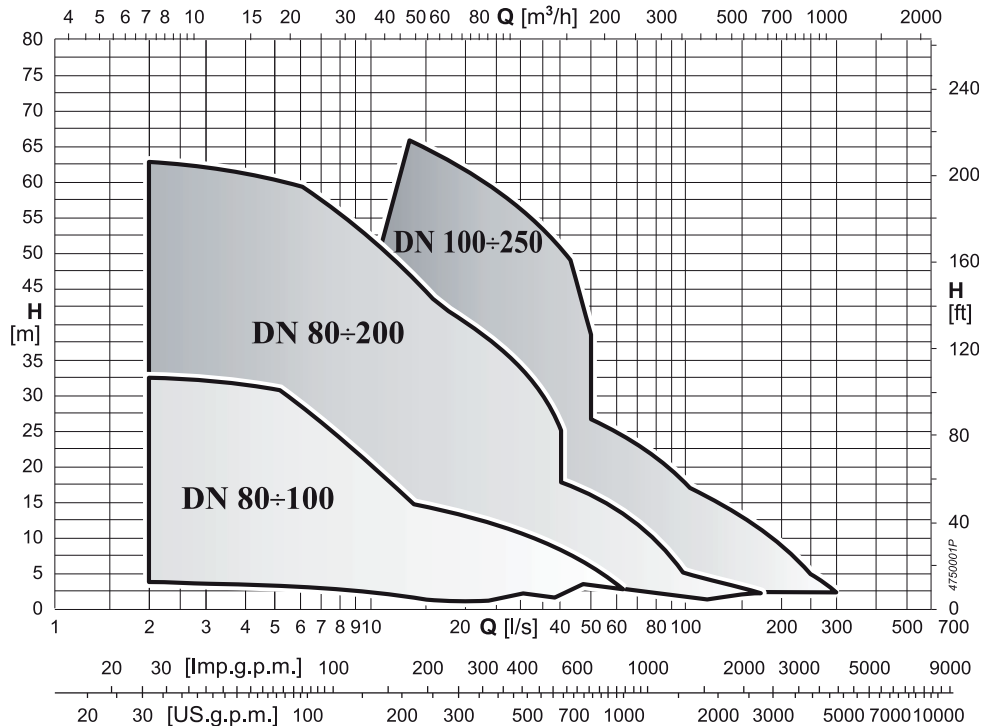

SUPPORTS

The pump shaft, on which the impeller is mounted, is guided by two bearings prelubricated with grease; Impeller side bearing supports the axial thrust. The pump is very compact with a short overhung shaft which reduces bearing loads so as to achieve optimum reliability and long life.

MECHANICAL SEALS

The double mechanical seal (series) is a dual guarantee safeguarding the pump station. If the seal on the pump side becomes faulty, the station will not be flooded thanks to the second seal on the joint side. These seals are made of particularly suitable materials able to withstand heavy-duty conditions; the pump side seal is made with abrasion proof materials.

SAFE OPERATION

The conductivity sensor in the oil chamber detects the presence of water and transmits the relative warning signal to the appropriately preset electric panel, checks that the mechanical seals on the pump side operate correctly and prevents loss of fluid from the pump unit.

PALIER

L'arbre de la pompe, sur lequel est montée directement la roue, est guidé par deux roulements lubrifiés à la graisse ; celui côté roue est dimensionné pour supporter la poussée axiale. La compacité particulière de la pompe permet la réduction du porte-à-faux de l'arbre et, par conséquent, la charge sur les roulements au bénéfice de la fiabilité et de la longévité.

GARNITURES MECANIQUES

La double garniture mécanique (montée de série) est une double garantie pour la station de pompage. En cas de rupture de la garniture côté pompe, la station ne subit aucune inondation grâce à la présence de la garniture côté joint. Elles sont en matériaux particulièrement adaptés aux conditions d'utilisation difficiles; la garniture côté pompe est particulièrement résistante aux particules abrasives.

SECURITE DE FONCTIONNEMENT

La sonde de conductivité présente dans la chambre à huile avertit la présence d'eau et le signale au coffret électrique prédisposé à cet effet, vérifie le bon fonctionnement des garnitures mécaniques et prévient les fuites de liquide du groupe de pompage.

SUPPORTAZIONE

L'albero della pompa, su cui è montata la girante, è guidato da due cuscinetti lubrificati a grasso; quello lato girante è dimensionato per la supportazione della spinta assiale. La particolare compattezza della pompa permette il contenimento della lunghezza dell'albero a sbalzo e, di conseguenza, il carico sui cuscinetti per una ottima affidabilità e durata.

TENUTE MECCANICHE

La doppia tenuta meccanica (montate in serie) è una doppia garanzia di salvaguardia della stazione di pompaggio. Nel caso di avaria della tenuta lato pompa la stazione non subisce allagamenti grazie alla presenza della tenuta lato giunto. Esse sono di materiali adatti per condizioni di impiego gravose; quella lato pompa è realizzata con materiali particolarmente resistenti all'abrasione.

SICUREZZA DI FUNZIONAMENTO

Il sensore di conduttività presente nella camera olio avverte presenza d'acqua e lo segnala al quadro elettrico adeguatamente predisposto, verifica il corretto funzionamento delle tenute meccaniche e previene le perdite di liquido dal gruppo di pompaggio.

The hydraulic part consists of the impeller and pump casing. An oil chamber fitted with two mechanical seals provides the seal system on the pump shaft. Electric pumps of the K-Kompact series feature three different hydraulics with the following characteristics.

La partie hydraulique est constituée d'une roue et d'un corps de pompe.

Le système d'étanchéité sur l'arbre pompe est obtenu au moyen d'une chambre à huile munie de deux garnitures mécaniques.

Dans les électropompes de la série K-Kompact sont montés trois différents systèmes hydrauliques ayant les caractéristiques suivantes.

La parte idraulica è costituita da girante e corpo pompa. Il sistema di tenuta sull'albero pompa è ottenuto da una camera d'olio dotata di due tenute meccaniche.

Nelle elettropompe della serie K-Kompact vengono montate tre diverse idrauliche con le seguenti caratteristiche.

<p>RETRACTED OPEN IMPELLER: W The impeller offers excellent reliability against clogging due to the feature of wide through passages, optimum resistance to wear thanks to the absence of shimming, versatility of use and the possibility to reduce the impellers in size. Thanks to the symmetry of its blades, there are no vibrations, even when they are worn. For water containing a large amount of solids and long fibres, sewage with a high gas and sludge content.</p> <p>ROUE VORTEX: TYPE W <i>Elle est caractérisée par une excellente résistance contre le colmatage, de larges sections de passages sphériques, une bonne robustesse à l'usure, grâce également à l'absence de canaux, une polyvalence d'emploi et la possibilité de rognage des roues. La symétrie de la disposition des aubes permet d'éliminer les vibrations, même en présence d'usure. Appropriée pour le relevage d'eaux ayant une concentration élevée de corps solides et à fibres longues, lisiers ayant une concentration élevée de gaz et de boues.</i></p> <p>GIRANTE APERTA ARRETRATA: W Caratterizzata da ottima sicurezza contro l'intasamento, larghi passaggi sferici, ottima resistenza all'usura, anche grazie all'assenza di rasamenti, versatilità d'impiego e possibilità di riduzione delle giranti. Grazie alla simmetria del palettaggio si ha assenza di vibrazioni anche in presenza di usura. Indicata per il sollevamento di acque con elevato contenuto di corpi solidi e a fibra lunga, liquami con alto contenuto di gas e fanghi.</p>	
<p>SINGLE-CHANNEL IMPELLER: M The impeller offers excellent reliability against clogging due to the feature of wide through passages, optimum resistance to wear, low mechanical action on the fluid, and high hydraulic efficiency. Particularly suitable for water containing solid and fibrous solids, cloacal water, sewage and sludge, and clean water. No vibrations thanks to the dynamically balanced impeller.</p> <p>ROUE MONOCANAL: TYPE M <i>Elle est caractérisée par une excellente résistance contre le colmatage, de larges sections de passages sphériques, une bonne robustesse à l'usure, une faible contrainte mécanique sur le fluide, un rendement hydraulique élevé. Particulièrement adaptée pour les eaux chargées contenant des corps solides et des fibres, les eaux résiduaires, les boues résultant du traitement des eaux, les eaux claires. Absence de vibrations grâce à la roue équilibrée dynamiquement.</i></p> <p>GIRANTE MONOCANALE: M Caratterizzata da ottima sicurezza contro l'intasamento, larghi passaggi sferici, ottima resistenza all'usura, bassa azione meccanica sul fluido, elevato rendimento idraulico. Particolarmente adatta per acque cariche contenenti corpi solidi e fibrosi, acque cloacali, liquami e fanghi, acque chiare. Assenza di vibrazioni grazie alla girante equilibrata dinamicamente.</p>	
<p>DOUBLE CHANNEL IMPELLER: D The impeller offers excellent reliability against clogging due to the feature of wide through passages, optimum resistance to wear, low mechanical action on the fluid, and high hydraulic efficiency. Particularly suitable for water containing solid and fibrous solids, cloacal water, sewage and sludge, and clean water. Thanks to the dynamically balanced impeller and the symmetry of its blades, there are no vibrations, even when they are worn.</p> <p>ROUE A 2 CANAUX: D <i>Elle est caractérisée par une bonne sécurité contre le bourrage, de larges passages sphériques, une bonne résistance à l'usure, une faible action mécanique sur le fluide, une haute performance hydraulique aux débits élevés. Tout particulièrement indiquée pour les eaux chargées contenant des corps solides et fibreux, les eaux d'égout, les lisiers et les boues, les eaux claires. Basses vibrations grâce à la roue équilibrée dynamiquement et à la symétrie de la disposition des aubes qui permet d'éliminer les vibrations, même en présence d'usure.</i></p> <p>GIRANTE BICANALE: D Caratterizzata da ottima sicurezza contro l'intasamento, larghi passaggi sferici, ottima resistenza all'usura, bassa azione meccanica sul fluido, elevato rendimento idraulico alle alte portate. Particolarmente adatta per acque cariche contenenti corpi solidi e fibrosi, acque cloacali, liquami e fanghi, acque chiare. Grazie alla girante equilibrata dinamicamente e alla simmetria del palettaggio si ha assenza di vibrazioni anche in presenza di usura.</p>	

All the experience acquired by Caprari with *non stop K+* hydraulics has been used for the K-Kompact series: the non-clogging hydraulic part and generously sized free passages do away with down times and costly maintenance work.

Toute l'expérience acquise par Caprari sur les parties hydrauliques non stop K+ a été transférée à la série K-Kompact: partie hydraulique non colmatable et passages libres amples évitent les arrêts de la machine et des interventions d'entretien coûteuses.

Tutta l'esperienza maturata da Caprari sulle idrauliche *non stop K+* è stata trasferita sulla serie K-Kompact: idraulica non intasabile e ampi passaggi liberi evitano fermi macchina e costosi interventi di manutenzione.

HORIZONTAL INSTALLATION

Upward or side outlet. The electric pump is fixed in place with support brackets.
 Horizontal intake. Minimum height measurement.

POSE HORIZONTALE

Avec orifice de refoulement vers le haut ou latéralement. La fixation de l'électropompe est effectuée avec étriers de support.

L'aspiration est horizontale et offre un encombrement minimum en hauteur.

INSTALLAZIONE ORIZZONTALE

Con bocca premente rivolta verso l'alto o lateralmente. Il fissaggio della elettropompa viene eseguito con staffe di sostegno. L'aspirazione è orizzontale con un contenuto ingombro in altezza.

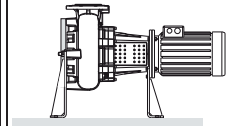

VERTICAL INSTALLATION

Assembly allowing easy inspection and maintenance, and minimum plan dimensions.
 Horizontal intake and delivery.

POSE VERTICALE

Cette disposition offre une bonne facilité de visite et d'entretien, ainsi que le minimum d'encombrement au sol. L'aspiration et le refoulement sont horizontaux.

INSTALLAZIONE VERTICALE

Questa disposizione consente la massima facilità di ispezione, manutenzione e minimo ingombro in pianta. L'aspirazione e la mandata sono orizzontali.

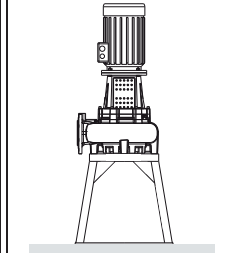

- Inverter resistant asynchronous, three-phase electric motor with short-circuit rotor, closed construction with fan ventilation, IP55 protection, class F insulation.
- Tolerable voltage: 230 V \pm 10%; 400 V \pm 10%.
- Maximum power draw unbalance: 5%.
- Maximum temperature of pumped fluid: 60°C.
- pH of raised fluid: 6 \div 10
- The pumped fluid can contain solids in suspension, the size of which must not exceed the open section in the hydraulic part.
- Contact our technical department if the density of the pumped fluid exceeds 1 kg/ dm³ and/or if the viscosity exceeds 1 mm²/s (1 cSt). If the percentage of dry matter in the fluid exceeds 4%, it will be necessary to consider the consequences of the variation in the specific weight and viscosity of the fluid. The acoustic pressure level issued by the machine within the forecast operating field is given in the manual.
- Rotation direction: clockwise viewed from motor side.
- Equipped with PTC temperature probe standard from 11 kW

The new K-Kompact electric pumps for wastewater are fitted with standardized surface motors in the IE3 efficiency class (according to standard IEC60034-30-1:2015 and Regulation 640/2009).

- *Moteur électrique "résistant aux ondulations", asynchrone, triphasé, avec rotor en court-circuit, construction fermée à ventilateur externe, protection IP55 ; isolement classe F.*
- *Variation de la tension d'alimentation: 230 V \pm 10%; 400 V \pm 10%.*
- *Déséquilibre maximum admis sur le courant absorbé: 5%.*
- *Température maxi. du liquide pompé: 60 °C.*
- *pH du liquide à relever: 6 à 10.*
- *Le liquide véhiculé peut contenir des corps solides en suspension dont la dimension ne dépasse pas le passage libre dans la partie hydraulique.*
- *En présence d'une densité supérieure à 1kg/dm³ et/ou une viscosité supérieure à 1 mm²/s (1 cSt) consulter directement nos services techniques. Si le liquide à pomper contient un pourcentage de matière sèche de plus de 4%, il faut prendre en compte les conséquences provoquées par la variation du poids spécifique et de la viscosité du mélange liquide.*
- *Le niveau acoustique émis par la machine dans la plage de fonctionnement prévue est indiqué sur le manuel.*
- *Rotation: dans le sens des aiguilles d'une montre vu du côté moteur.*
- *Avec sonde de température PTC standard de 11 kW*

Les nouvelles électropompes pour eaux usées K-Kompact montent des moteurs de surface normalisés, classe de rendement IE3 (d'après la norme IEC60034-30-1:2015 et le Règlement 640/2009).

- **Motore elettrico "inverter resistant" asincrono, trifase, con rotore in corto circuito, costruzione chiusa a ventilazione esterna, protezione IP55; isolamento classe F.**
- **Variazione della tensione di alimentazione: 230 V \pm 10%; 400 V \pm 10%.**
- **Squilibrio massimo ammesso sulla corrente assorbita: 5%.**
- **Temperatura max. liquido pompato: 60°C.**
- **pH del liquido da sollevare: 6 \div 10.**
- **Il liquido pompato può contenere corpi solidi in sospensione la cui grandezza non sia superiore al passaggio libero nella parte idraulica.**
- **Interpellare i nostri uffici tecnici in presenza di una densità superiore a 1 kg/dm³ e/o di una viscosità superiore a 1 mm²/s (1 cSt). Se si riscontra una percentuale secca del fluido superiore al 4% occorre considerare le conseguenze dovute alla variazione del peso specifico e della viscosità della miscela liquida. Il livello di pressione acustica emesso dalla macchina nel campo di funzionamento previsto, è riportato sul manuale.**
- **Senso di rotazione: orario visto dal lato motore.**
- **Dotato di sonda di temperatura standard da 11 kW**

Le nuove elettropompe per acque cariche K-Kompact montano motori di superficie normalizzati in classe di efficienza IE3 (secondo normativa IEC60034-30-1:2015 e Regolamento 640/2009).

Performance ranges
Champs de performance
Campo di prestazioni

**KKCW080H
KKCM080H
KKCW100H
KKCM100H**

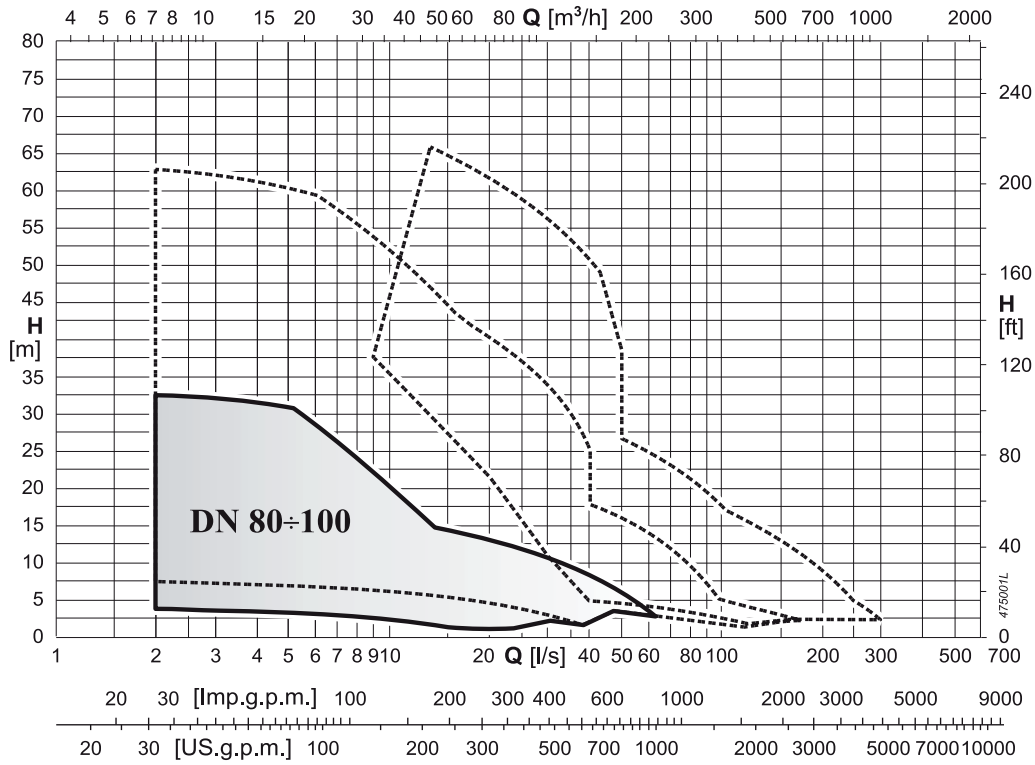

K-Kompact DN 80÷100

caprari

Electric pump coding
Exemplification du sigle de l'électropompe
Esemplificazione sigla elettropompa

KKCW080H
KKCM080H
KKCW100H
KKCM100H

Motor code match
Codes communs avec le sigle moteur
Comunanze con sigla motore

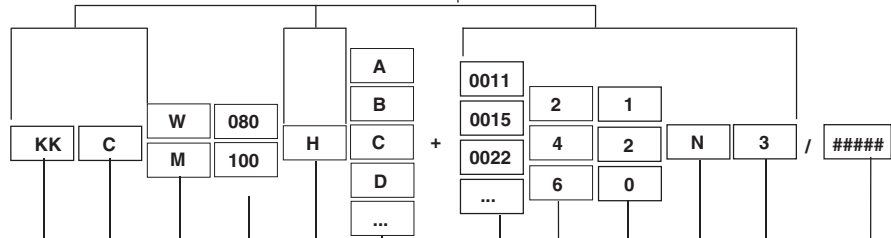

Series - Série - Serie

50 Hz

Impeller: vortex "W"; single-channel "M"
Roue: vortex "W"; monocanal "M"
Girante: a vortice "W"; monocanale "M";

Size of pump end (DNm)
Grandeur partie hydraulique (DNm)
Grandezza parte idraulica (DNm)

Size of electric motor flanging
Dimension bride moteur électrique
Grandezza flangiatura motore elettrico

Impeller diameter - Réduction roue - Riduzione girante

Motor output power code
Code puissance rendemet moteur
Codice potenza resa motore

Number of poles - Nombre de pôles - Numero poli

Constructional features of electric motor threephase, class F insulation, IP55-IEC protection degree
Caractéristiques de fabrication moteur électrique triphasé, classe d'isolation F, degré de protection IP55-IEC
Caratteristiche costruttive motore elettrico trifase, classe di isolamento F, grado di protezione IP55-IEC
1 = 230 (220-240) V- Δ / 400 (380-415) V-Y
2 = 400 (380-415) V- Δ / 700 (660-720) V-Y
0 = Specials - Spéciaux - Speciali

Standard electric pump: (N) ;
Electropompe standard: (N) ;
Elettropompa standard: (N) ;

Generational code - Code générationnel - Codice generazionale

Various specialities - Spécialités diverses - Specialità varie

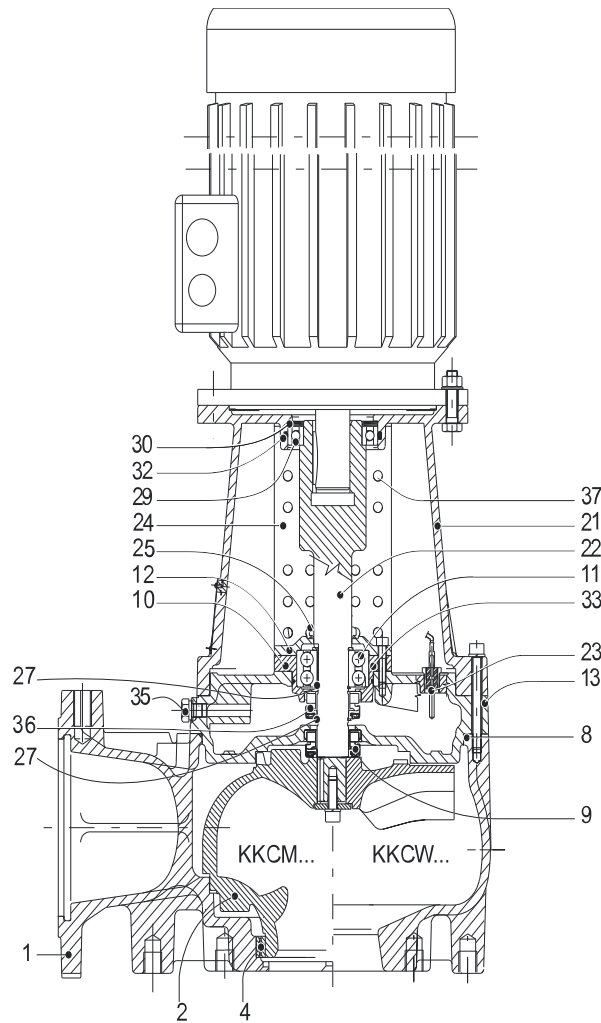

Pos.	Parts	Materials	Nomenclature	Matériaux	Nomenclatura	Materiale
1	Delivery body	Cast iron	Corps de refoulement	Fonte grise	Corpo mandata	Ghisa grigia
2	Impeller	Cast iron	Roue	Fonte grise	Girante	Ghisa grigia
4	Wear ring	Steel/Rubber	Bague d'usure	Acier/Caoutchouc	Anello sede girante	Acciaio/Gomma
8 - 32 - 33	Seal ring	Rubber	Bague d'étanchéité	Caoutchouc	Anello di tenuta OR	Gomma
9	Mechanical seal on pump side	Ceramic/graphite	Garniture mécanique côté pompe	Céramique/graphite	Tenuta meccanica lato pompa	Ceramica/grafite
10	Bearing support	Nodular cast iron	Support de roulement	Fonte sphéroïdale	Supporto cuscinetto	Ghisa sferoidale
11 - 29	bearing	-	roulement	-	Cuscinetto	-
12	Flange bearing	Cast iron	Bride roulement	Fonte grise	Flangia cuscinetto	Ghisa grigia
13	Oil box	Cast iron	Chambre à huile	Fonte grise	Scatola olio	Ghisa grigia
21	Lantern bracket	Cast iron	Lanterne support	Fonte grise	Supporto di collegamento	Ghisa grigia
22	Pump shaft	Stainless steel	Arbre de pompe	Acier inox	Albero pompa	Acciaio inox
23	Conductivity probe	Brass	Sondes de conductivité	Laiton	Sonda di conduttività	Ottone
24	Protective casing	Stainless steel	Carter de protection	Acier inox	Carter di protezione	Acciaio inox
25	Seal ring	Rubber	Bague d'étanchéité	Caoutchouc	Anello di tenuta	Gomma
27	Elastic ring	Steel	Circlip	Acier	Anello elastico	Acciaio
30	Belleville washer	Stainless steel	Rondelle Belleville	Acier inox	Molla a tazza	Acciaio inox
35	Plug	Stainless steel	Bouchon	Acier inox	Tappo	Acciaio inox
36	Mechanical seal on motor side	Ceramic/graphite	Garniture mécanique côté moteur	Céramique/graphite	Tenuta meccanica lato motore	Ceramica/grafite
37	Probe holder	Rubber	Porte-sonde	Caoutchouc	Porta sondino	Gomma

Screws and nuts in stainless steel.
Sondativity probe in the motor casing

Vits et écrous en acier inox.
Sonde de conductivité dans l'enveloppe du moteur

Viti e dadi in acciaio inox.
Sonda di conduttività nella carcassa motore

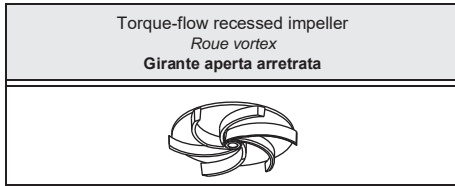

Type Type Tipo	KKCW080H.+...N3	
Conductivity probe Sonde de conductivité Sonda di conduttività	Yes Oui Si	

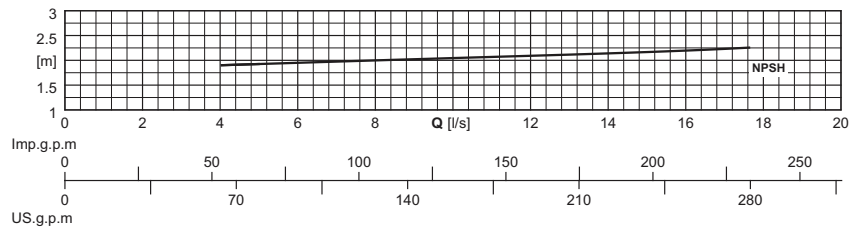
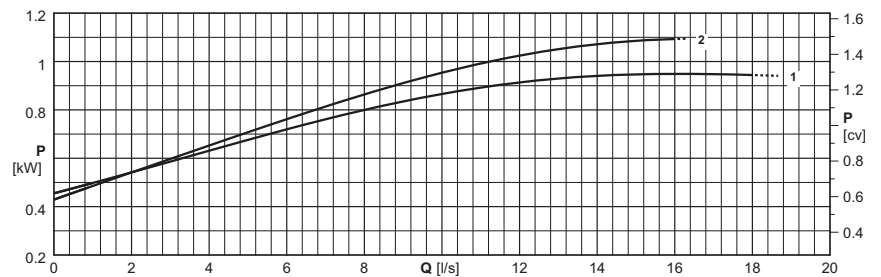
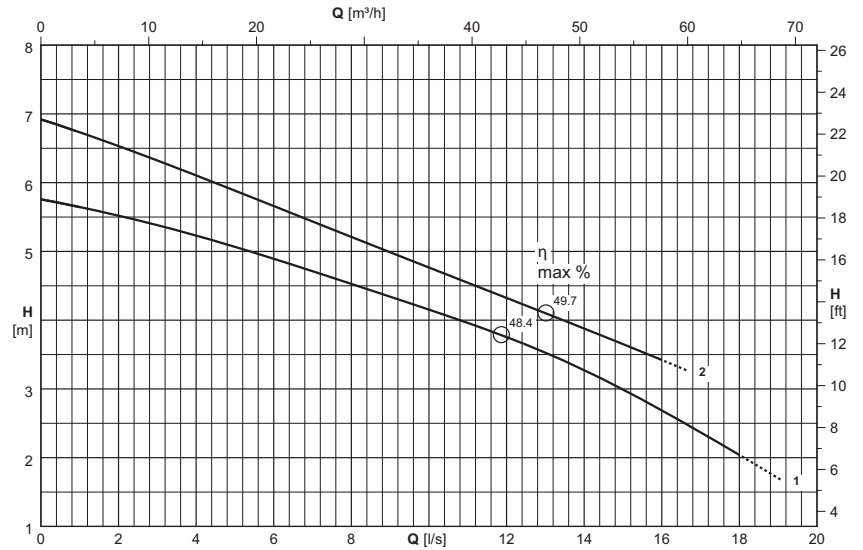

Electric pump type <i>Electropompe type</i> Elettropompa tipo	Curve <i>Courbe</i> Curva	Motor power <i>Puiss. moteur</i> Potenza motore	Capacity <i>Debit</i> Portata														
			[l/s]	0	2	4	6	8	10	12	14	16	18	20			
		P ₂	[m³/h]	0	7,2	14,4	21,5	29	36	43	50	58	65	72			
	(N°)	[kW]	Head <i>Hauteur</i> Prevalenza														
KKCW080HE+001161N3	1	1,1	[m]	5,8	5,5	5,2	4,9	4,5	4,2	3,8	3,3	2,7	2				
KKCW080HC+001161N3	2	1,1	[m]	6,9	6,5	6,1	5,7	5,2	4,8	4,3	3,9	3,4					
NPSH _R			[m]			1,9	2	2	2	2,1	2,1	2,2					

P₂ = Power rated by the motor

Performance tolerance as per:
UNI/ISO 9906 Grade 3B

For the accessories specification see page "Accessories"

The hatched part of the curve represents the out-of-range of operation.

The impellers will be trimmed to meet the duty point

The performance values refer to units with Caprari motors.

P₂ = Puissance restituée par le moteur

Tolérances sur les performances selon normes:
UNI/ISO 9906 Niveau 3B

Pour les accessoires voir page "Accessories"

La partie pointillée de la courbe indique l'utilisation hors de la plage.

Le point de fonctionnement désiré peut être obtenu par rognage de roue

Les performances se réfèrent à des groupes avec moteurs Caprari.

P₂ = Potenza resa dal motore

Tolleranze sulle prestazioni secondo norme:
UNI/ISO 9906 Grado 3B

Per accessori vedere pagina accessori

La parte tratteggiata della curva rappresenta il fuori campo di utilizzo.

Le giranti vengono tornite in modo da ottenere il punto di lavoro richiesto

Le prestazioni sono riferite a gruppi con motori Caprari.

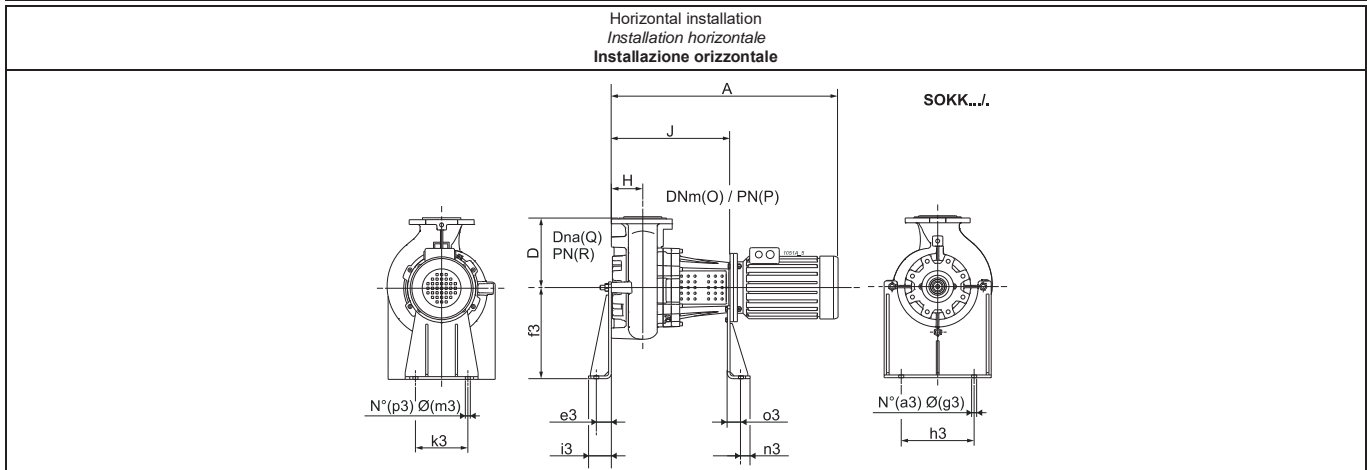
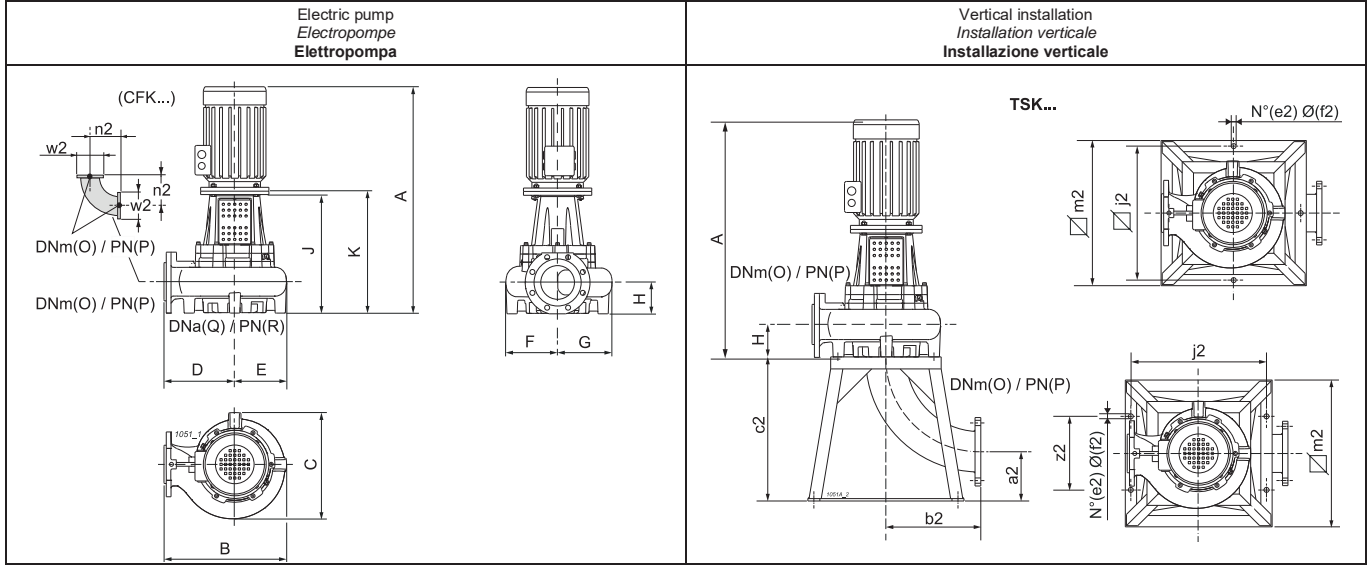

Type Type Tipo	Free passage Passage libre Passaggio Libero		Weight Poids Peso	A	B	C	D	E	F	G	H	J	K	O	P	Q	R	a2	a3	b2
	[mm]	[kg]		[mm]																
KKCW080HE+001161N3	Ø 80	72	72	750	391	292	245	146	146	146	92	400	415	80	16	80	16 (*)	126	2	164
KKCW080HC+001161N3	Ø 80	66	66	750	391	292	245	146	146	146	92	400	415	80	16	80	16 (*)	126	2	164
Type Type Tipo	c2	e2	e3	f2	f3	g3	h3	i3	j2	k3	m2	m3	n2	n3	o3	p3	w2	z2		
	[mm]																			
KKCW080HE+001161N3	290	4	66	12	400	22	270	100	390	230	440	22	164	40	48	2	200	230		
KKCW080HC+001161N3	290	4	66	12	400	22	270	100	390	230	440	22	164	40	48	2	200	230		

For the accessories specification see page "Accessories"
(*) = Consult the flanges page for the flange dimensions.

Pour les accessoires voir page "Accessories"
(*) = Pour les dimensions des brides, voir page brides.

Per accessori vedere pagina accessori
(*) = Per dimensioni flange, vedere pagina flange.

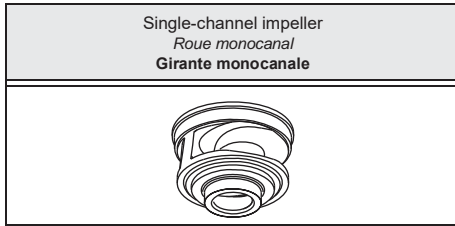

Type Type Tipo	KKCM080H...+...N3	
Conductivity probe Sonde de conductivité Sonda di conduttività	Yes Oui Sì	

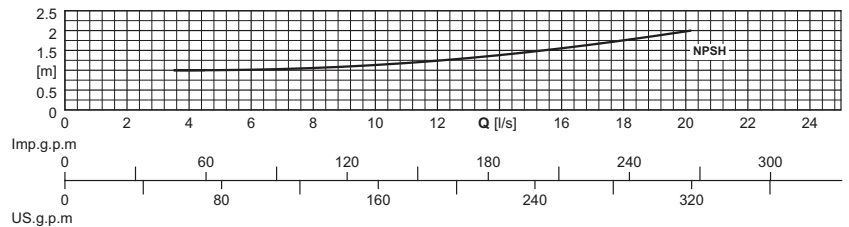
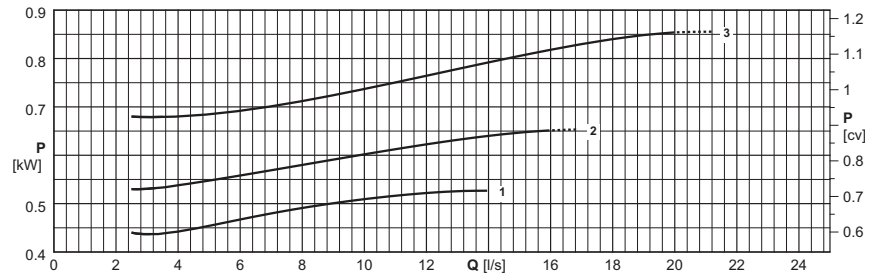
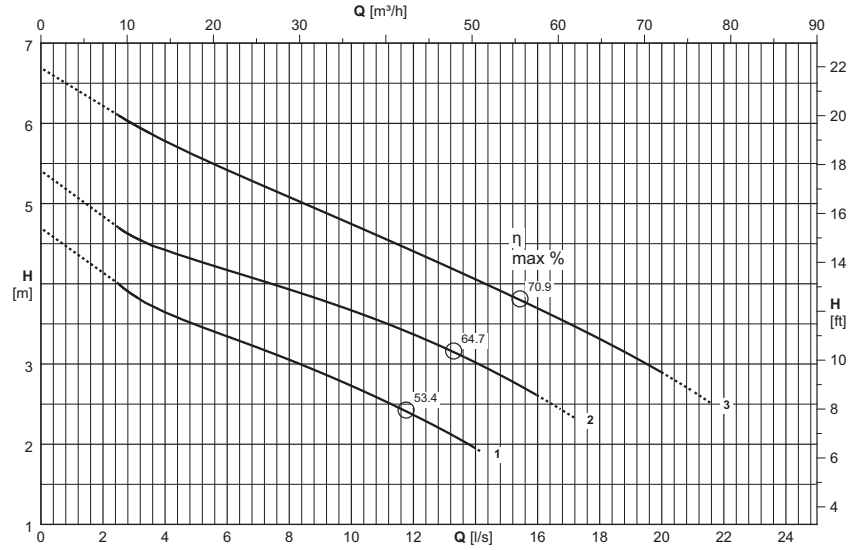

Electric pump type <i>Electropompe type</i> Elettropompa tipo	Curve <i>Courbe</i> Curva	Motor power <i>Puiss. moteur</i> Potenza motore	Capacity <i>Debit</i> Portata													
			[l/s]	0	4	6	8	10	12	14	16	18	20	22		
		P_2	[m³/h]	0	14,4	21,5	29	36	43	50	58	65	72	79		
	(N°)	[kW]	Head <i>Hauteur</i> Prevalenza													
KKCM080HG+001161N3	1	1,1	[m]	4,7	3,6	3,3	3,1	2,7	2,4	1,9						
KKCM080HD+001161N3	2	1,1	[m]	5,4	4,4	4,2	3,9	3,7	3,4	3	2,6					
KKCM080HA+001161N3	3	1,1	[m]	6,7	5,8	5,4	5,1	4,7	4,4	4,1	3,7	3,3	2,9			
NPSH _R			[m]		1	1	1,1	1,1	1,2	1,4	1,5	1,7	1,9			

P_2 = Power rated by the motor
Performance tolerance as per:
UNI/ISO 9906 Grade 3B
For the accessories specification see page "Accessories"
The hatched part of the curve represents the out-of-range of operation.
The performance values refer to units with Caprari motors.

P_2 = Puissance restituée par le moteur
Tolérances sur les performances selon normes:
UNI/ISO 9906 Niveau 3B
Pour les accessoires voir page "Accessories"
La partie pointillée de la courbe indique l'utilisation hors de la plage.
Les performances se réfèrent à des groupes avec moteurs Caprari.

P_2 = Potenza resa dal motore
Tolleranze sulle prestazioni secondo norme:
UNI/ISO 9906 Grado 3B
Per accessori vedere pagina accessori
La parte tratteggiata della curva rappresenta il fuori campo di utilizzo.
Le prestazioni sono riferite a gruppi con motori Caprari.

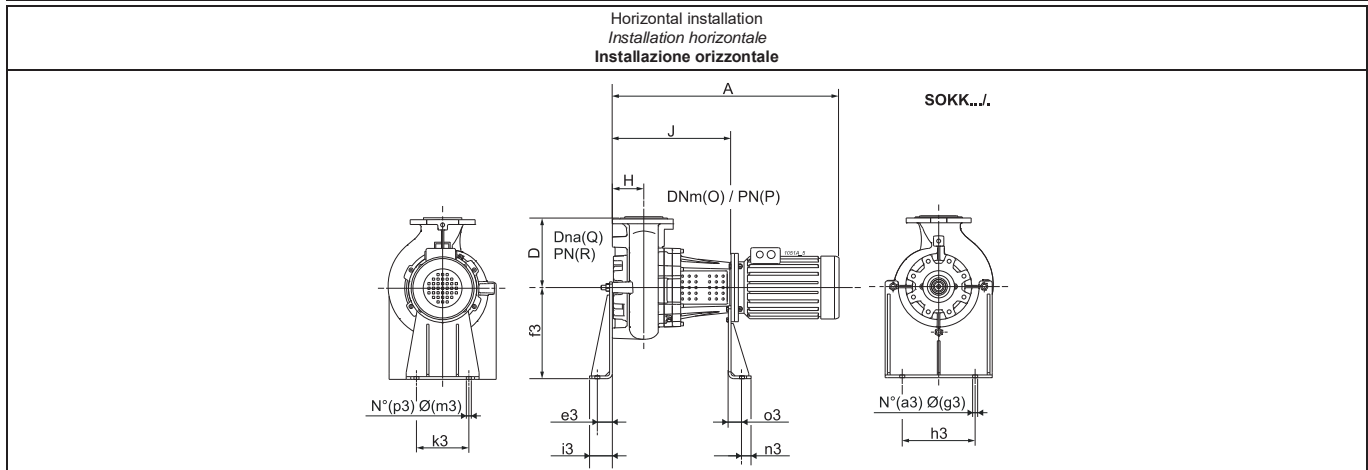
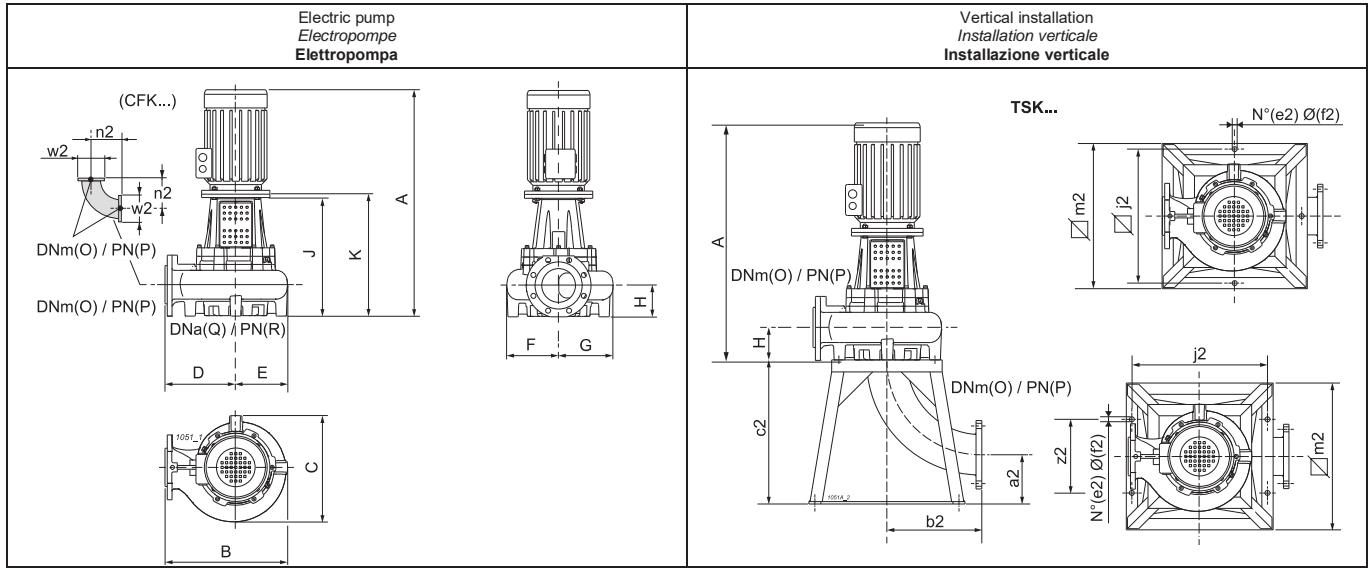

Type Type Tipo	Free passage Passage libre Passaggio Libero	Weight Poids Peso	A	B	C	D	E	F	G	H	J	K	O	P	Q	R	a2	a3	b2
	[mm]		[kg]	[mm]															
KKCM080HG+001161N3	Ø 75	72	759	407	317	245	162	144	173	121	409	424	80	16	80	16 (*)	126	2	164
KKCM080HD+001161N3	Ø 75	72	759	407	317	245	162	144	173	121	409	424	80	16	80	16 (*)	126	2	164
KKCM080HA+001161N3	Ø 75	72	759	407	317	245	162	144	173	121	409	424	80	16	80	16 (*)	126	2	164
Type Type Tipo	c2	e2	e3	f2	f3	g3	h3	i3	j2	k3	m2	m3	n2	n3	o3	p3	w2	z2	
	[mm]																		
KKCM080HG+001161N3	290	4	66	12	400	22	270	100	390	230	440	22	164	40	48	2	200	230	
KKCM080HD+001161N3	290	4	66	12	400	22	270	100	390	230	440	22	164	40	48	2	200	230	
KKCM080HA+001161N3	290	4	66	12	400	22	270	100	390	230	440	22	164	40	48	2	200	230	

For the accessories specification see page "Accessories"
(*) = Consult the flanges page for the flange dimensions.

Pour les accessoires voir page "Accessories"
(*) = Pour les dimensions des brides, voir page brides.

Per accessori vedere pagina accessori
(*) = Per dimensioni flange, vedere pagina flange.

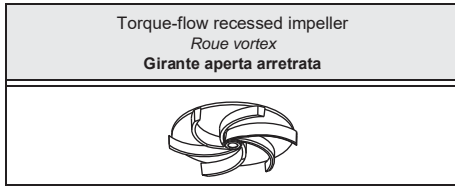

Type Type Tipo	KKCW080H...+...N3	
Conductivity probe Sonde de conductivité Sonda di conduttività	Yes Oui Sì	

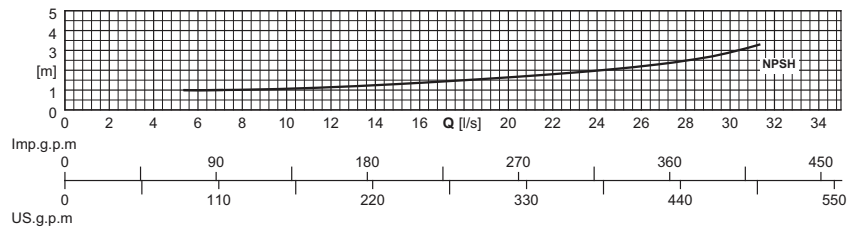
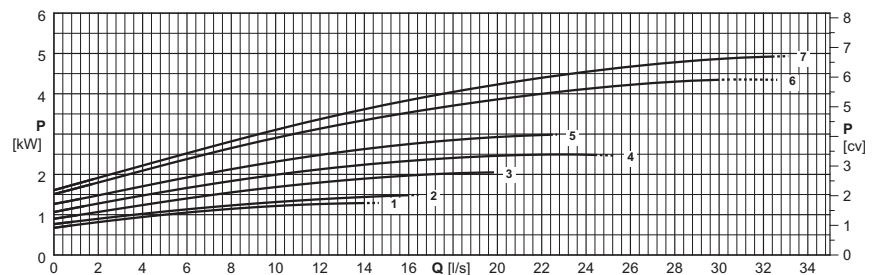
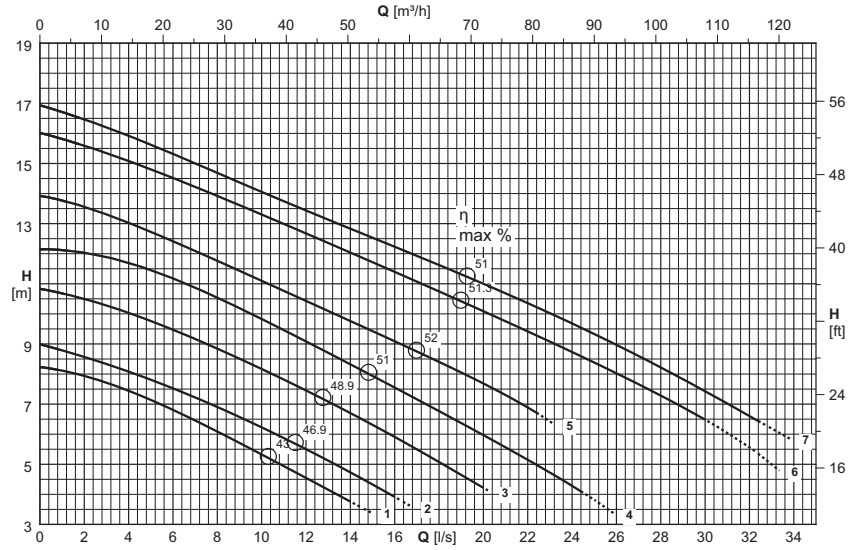

Electric pump type Electropompe type Elettropompa tipo	Curve Courbe Curva	Motor power Puiss. moteur Potenza motore	Capacity Debit Portata														
			[l/s]	0	3	6	9	12	15	18	21	24	27	30	33		
		P ₂	[m³/h]	0	10,8	21,5	32	43	54	65	76	86	97	108	119		
	(N°)	[kW]	Head Hauteur Prevalenza														
KKCW080HN+001541N3	1	1,5	[m]	8,2	7,7	6,8	5,7	4,5									
KKCW080HM+001541N3	2	1,5	[m]	9	8,3	7,5	6,6	5,5	4,3								
KKCW080HI+002241N3	3	2,2	[m]	10,8	10,3	9,5	8,5	7,5	6,3	5,1							
KKCW080HH+003041N3	4	3	[m]	12,1	11,9	11,2	10,2	9,1	7,9	6,8	5,6	4,3					
KKCW080HE+003041N3	5	3	[m]	13,9	13,3	12,4	11,4	10,4	9,4	8,4	7,3						
KKCW080HC+005542N3	6	5,5	[m]	16	15,3	14,5	13,6	12,7	11,7	10,7	9,8	8,7	7,7	6,5	5		
KKCW080HA+005542N3	7	5,5	[m]	16,9	16,2	15,3	14,4	13,4	12,5	11,6	10,7	9,7	8,6	7,4	6,2		
NPSH _R			[m]			1	1	1,2	1,3	1,5	1,6	1,9	2,3	2,6			

P₂ = Power rated by the motor

Performance tolerance as per:
UNI/ISO 9906 Grade 3B

For the accessories specification see page "Accessories"

The hatched part of the curve represents the out-of-range of operation.

The impellers will be trimmed to meet the duty point

The performance values refer to units with Caprari motors.

P₂ = Puissance restituée par le moteur

Tolérances sur les performances selon normes:
UNI/ISO 9906 Niveau 3B

Pour les accessoires voir page "Accessories"

La partie en pointillé de la courbe indique l'utilisation hors de la plage.

Le point de fonctionnement désiré peut être obtenu par rognage de roue

Les performances se réfèrent à des groupes avec moteurs Caprari.

P₂ = Potenza resa dal motore

Tolleranze sulle prestazioni secondo norme:
UNI/ISO 9906 Grado 3B

Per accessori vedere pagina accessori

La parte tratteggiata della curva rappresenta il fuori campo di utilizzo.

Le giranti vengono tornite in modo da ottenere il punto di lavoro richiesto

Le prestazioni sono riferite a gruppi con motori Caprari.

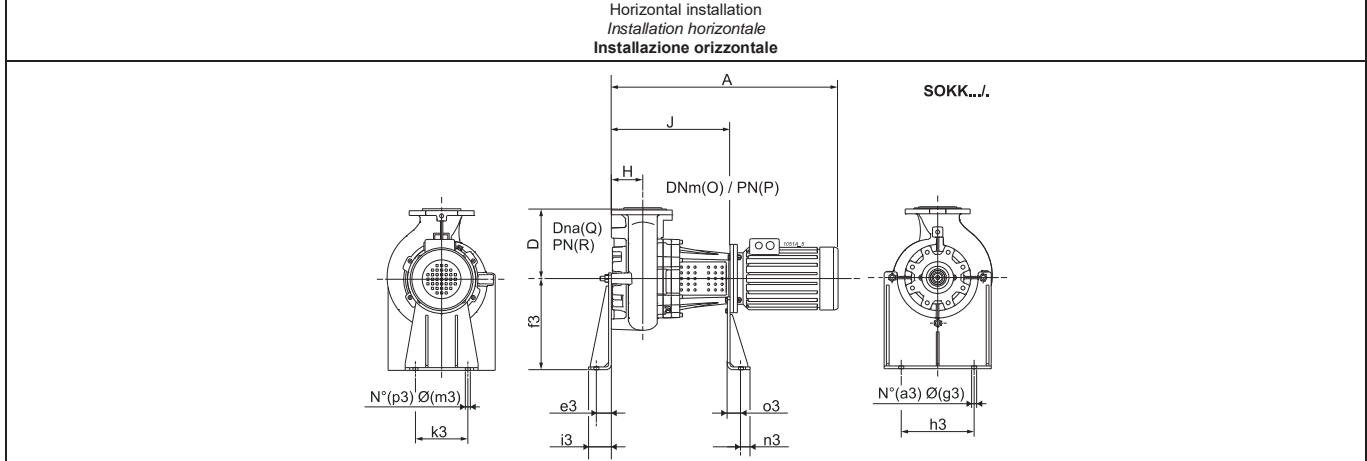
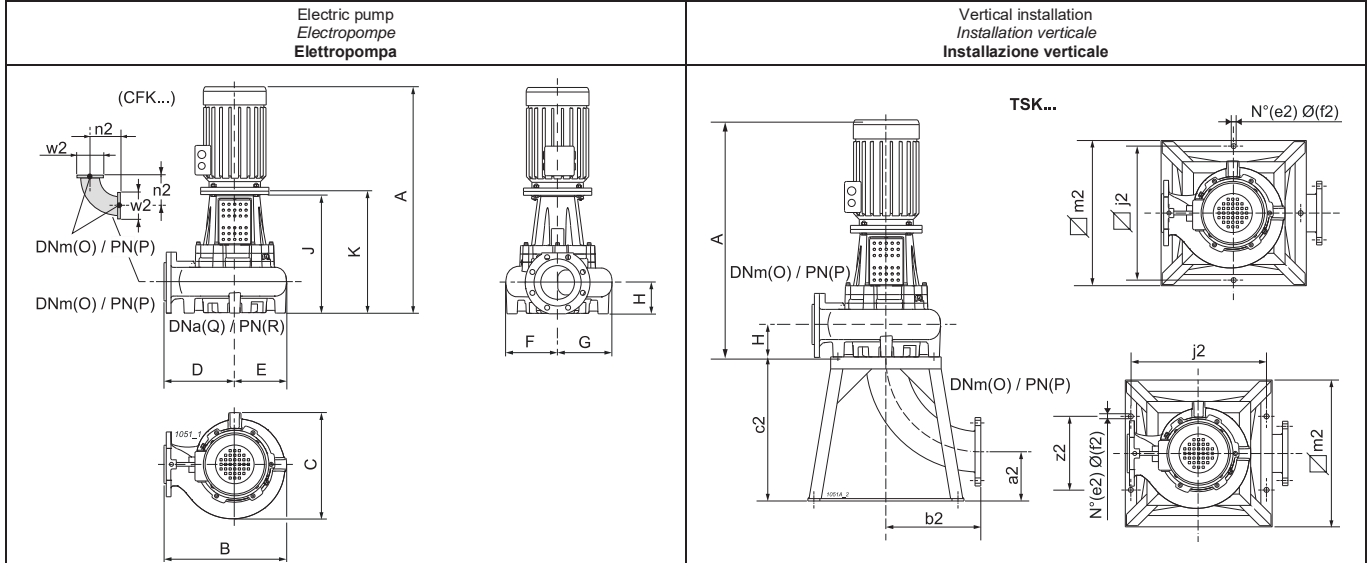

Type Type Tipo	Free passage Passage libre Passaggio Libero	Weight Poids Peso	[mm]																
			A	B	C	D	E	F	G	H	J	K	O	P	Q	R	a2	a3	b2
KKCW080HN+001541N3	Ø 80	65	750	391	292	245	146	146	146	92	400	415	80	16	80	16 (*)	126	2	164
KKCW080HM+001541N3	Ø 80	65	750	391	292	245	146	146	146	92	400	415	80	16	80	16 (*)	126	2	164
KKCW080HI+002241N3	Ø 80	69	762	391	292	245	146	146	146	92	400	417	80	16	80	16 (*)	126	2	164
KKCW080HH+003041N3	Ø 80	73	762	391	292	245	146	146	146	92	400	417	80	16	80	16 (*)	126	2	164
KKCW080HE+003041N3	Ø 80	79	762	391	292	245	146	146	146	92	400	417	80	16	80	16 (*)	126	2	164
KKCW080HC+005542N3	Ø 80	86	812	391	292	245	146	146	146	92	420	437	80	16	80	16 (*)	126	2	164
KKCW080HA+005542N3	Ø 80	86	812	391	292	245	146	146	146	92	420	437	80	16	80	16 (*)	126	2	164

Type Type Tipo	[mm]																		
	c2	e2	e3	f2	f3	g3	h3	i3	j2	k3	m2	m3	n2	n3	o3	p3	w2	z2	
KKCW080HN+001541N3	290	4	66	12	400	22	270	100	390	230	440	22	164	40	48	2	200	230	
KKCW080HM+001541N3	290	4	66	12	400	22	270	100	390	230	440	22	164	40	48	2	200	230	
KKCW080HI+002241N3	290	4	66	12	400	22	270	100	390	230	440	22	164	40	48	2	200	230	
KKCW080HH+003041N3	290	4	66	12	400	22	270	100	390	230	440	22	164	40	48	2	200	230	
KKCW080HE+003041N3	290	4	66	12	400	22	270	100	390	230	440	22	164	40	48	2	200	230	
KKCW080HC+005542N3	290	4	66	12	400	22	270	100	390	230	440	22	164	40	48	2	200	230	
KKCW080HA+005542N3	290	4	66	12	400	22	270	100	390	230	440	22	164	40	48	2	200	230	

For the accessories specification see page "Accessories"
 (*) = Consult the flanges page for the flange dimensions.

Pour les accessoires voir page "Accessories"
 (*) = Pour les dimensions des brides, voir page brides.

Per accessori vedere pagina accessori
 (*) = Per dimensioni flange, vedere pagina flange.

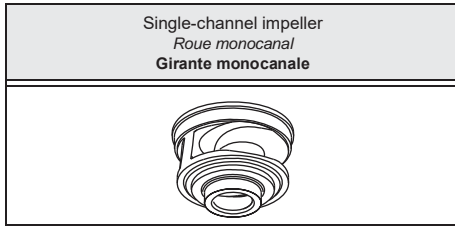

Type Type Tipo	KKCM080H...+...N3	
Conductivity probe Sonde de conductivité Sonda di conduttività	Yes Oui Sì	

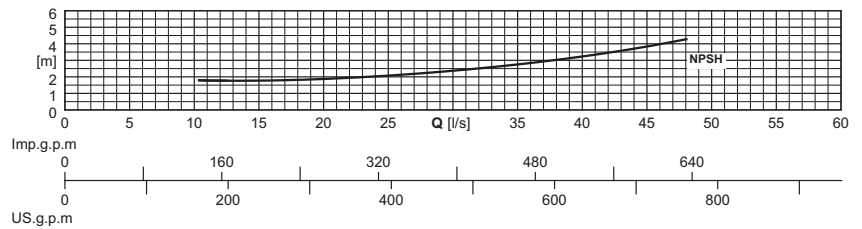
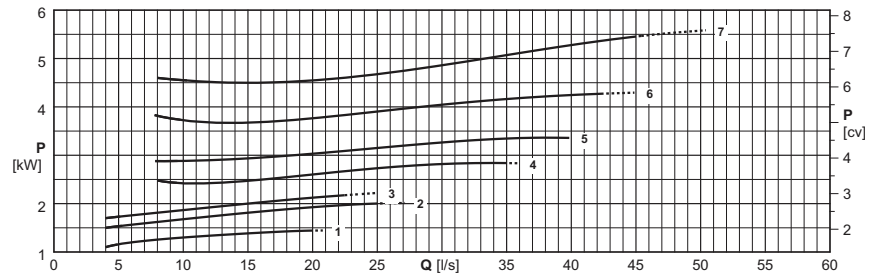
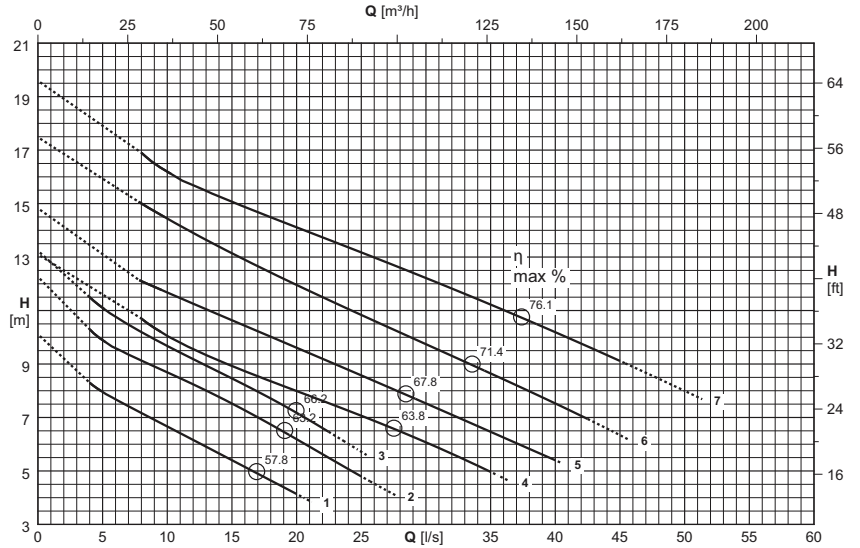

Electric pump type Electropompe type Elettropompa tipo	Curve Courbe Curva	Motor power Puiss. moteur Potenza motore	Capacity Debit Portata												
			[l/s]	0	5	10	15	20	25	30	35	40	45	50	55
		P ₂	[m³/h]	0	18	36	54	72	90	108	126	144	162	180	198
	(N°)	[kW]	Head Hauteur Prevalenza												
			[m]	10,1	8	6,7	5,4	4,1							
KKCM080HG+001541N3	1	1,5	[m]	10,1	8	6,7	5,4	4,1							
KKCM080HD+002241N3	2	2,2	[m]	12,3	9,9	8,7	7,5	6,2	4,8						
KKCM080HC+002241N3	3	2,2	[m]	13,2	11,1	9,7	8,5	7,2	5,7						
KKCM080HL+003041N3	4	3	[m]	13,1	-	10,1	8,9	8	7,1	6,1	5				
KKCM080HG+004041N3	5	4	[m]	14,8	-	11,7	10,6	9,6	8,6	7,5	6,5	5,4			
KKCM080HD+005542N3	6	5,5	[m]	17,5	-	14,4	13,1	12	10,8	9,7	8,6	7,5	6,3		
KKCM080HA+005542N3	7	5,5	[m]	19,6	-	16,2	15,1	14,1	13,2	12,2	11,2	10,2	9,1	8	
NPSH _R			[m]				1,8	1,9	2	2,3	2,6	3,2	3,8		

P₂ = Power rated by the motor

Performance tolerance as per:
UNI/ISO 9906 Grade 3B

For the accessories specification see page "Accessories"

The hatched part of the curve represents the out-of-range of operation.

The performance values refer to units with Caprari motors.

P₂ = Puissance restituée par le moteur

Tolérances sur les performances selon normes:
UNI/ISO 9906 Niveau 3B

Pour les accessoires voir page "Accessories"

La partie pointillée de la courbe indique l'utilisation hors de la plage.

Les performances se réfèrent à des groupes avec moteurs Caprari.

P₂ = Potenza resa dal motore

Tolleranze sulle prestazioni secondo norme:
UNI/ISO 9906 Grado 3B

Per accessori vedere pagina accessori

La parte tratteggiata della curva rappresenta il fuori campo di utilizzo.

Le prestazioni sono riferite a gruppi con motori Caprari.

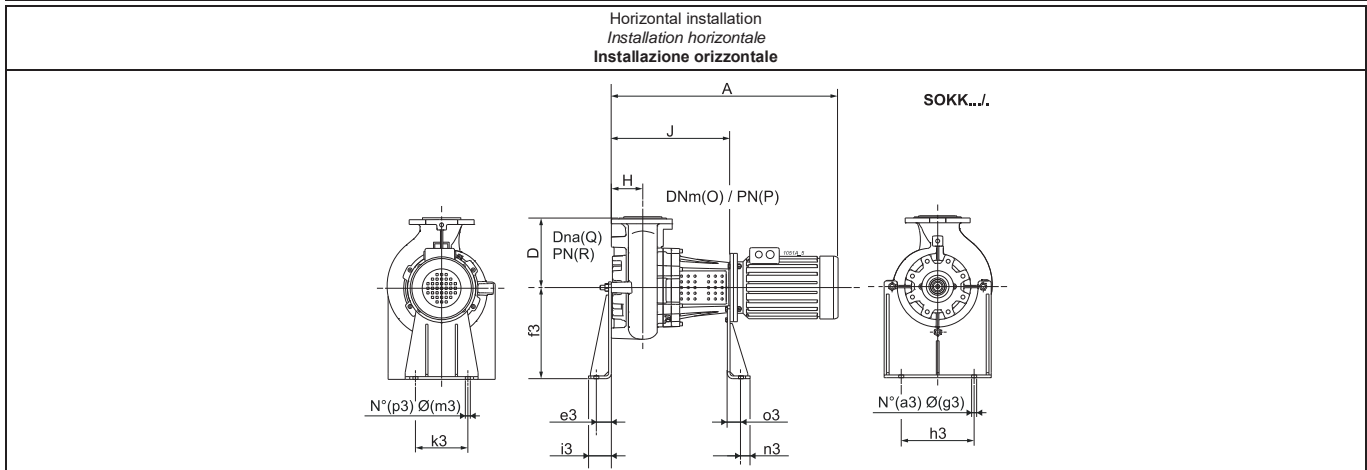
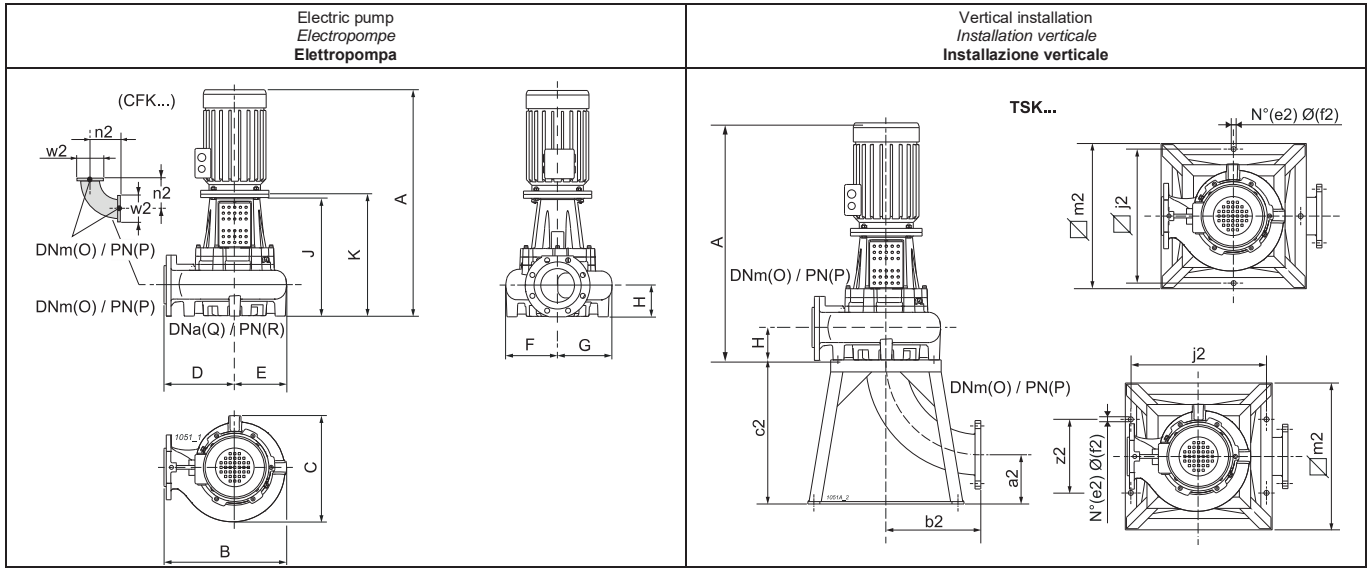

Type Type Tipo	Free passage Passage libre Passaggio Libero	Weight Poids Peso	A	B	C	D	E	F	G	H	J	K	O	P	Q	R	a2	a3	b2
			[mm]	[kg]	[mm]														
KKCM080HG+001541N3	Ø 75	72	759	407	317	245	162	144	173	121	409	424	80	16	80	16 (*)	126	2	164
KKCM080HD+002241N3	Ø 75	76	771	407	317	245	162	144	173	121	409	426	80	16	80	16 (*)	126	2	164
KKCM080HC+002241N3	Ø 75	76	771	407	317	245	162	144	173	121	409	426	80	16	80	16 (*)	126	2	164
KKCM080HL+003041N3	Ø 80	94	758	435	369	255	180	172	197	118	396	413	80	16	100	16	135	2	204
KKCM080HG+004041N3	Ø 80	100	793	435	369	255	180	172	197	118	396	413	80	16	100	16	135	2	204
KKCM080HD+005542N3	Ø 80	117	788	435	369	255	180	172	197	118	396	413	80	16	100	16	135	2	204
KKCM080HA+005542N3	Ø 80	117	788	435	369	255	180	172	197	118	396	413	80	16	100	16	135	2	204
Type Type Tipo	c2	e2	e3	f2	f3	g3	h3	i3	j2	k3	m2	m3	n2	n3	o3	p3	w2	z2	
	[mm]																		
KKCM080HG+001541N3	290	4	66	12	400	22	270	100	390	230	440	22	164	40	48	2	200	230	
KKCM080HD+002241N3	290	4	66	12	400	22	270	100	390	230	440	22	164	40	48	2	200	230	
KKCM080HC+002241N3	290	4	66	12	400	22	270	100	390	230	440	22	164	40	48	2	200	230	
KKCM080HL+003041N3	340	4	66	22	400	22	320	100	600	230	650	22	164	40	48	2	200	600	
KKCM080HG+004041N3	340	4	66	22	400	22	320	100	600	230	650	22	164	40	48	2	200	600	
KKCM080HD+005542N3	340	4	66	22	400	22	320	100	600	230	650	22	164	40	48	2	200	600	
KKCM080HA+005542N3	340	4	66	22	400	22	320	100	600	230	650	22	164	40	48	2	200	600	

For the accessories specification see page "Accessories"
 (*) = Consult the flanges page for the flange dimensions.

Pour les accessoires voir page "Accessories"
 (*) = Pour les dimensions des brides, voir page brides.

Per accessori vedere pagina accessori
 (*) = Per dimensioni flange, vedere pagina flange.

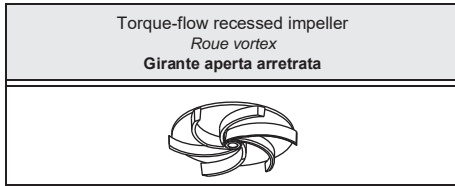

Type Type Tipo	KKCW080H...+...N3	
Conductivity probe Sonde de conductivité Sonda di conduttività	Yes Oui Si	

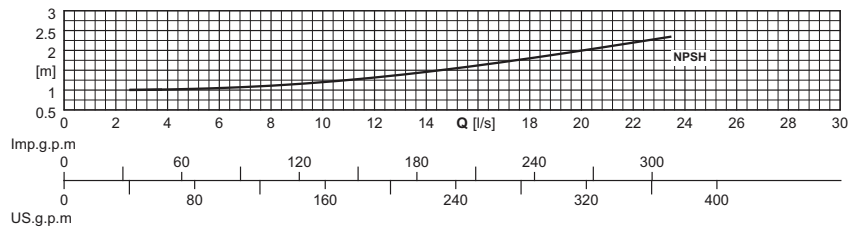
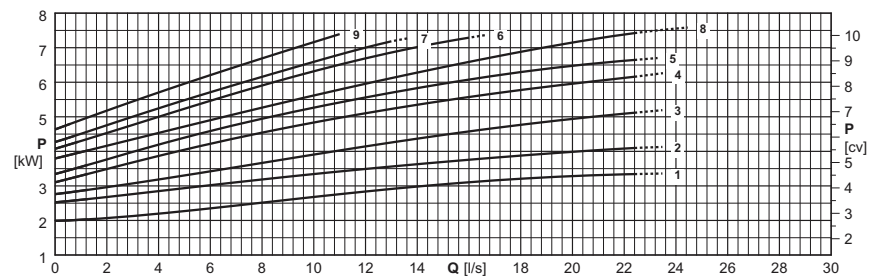
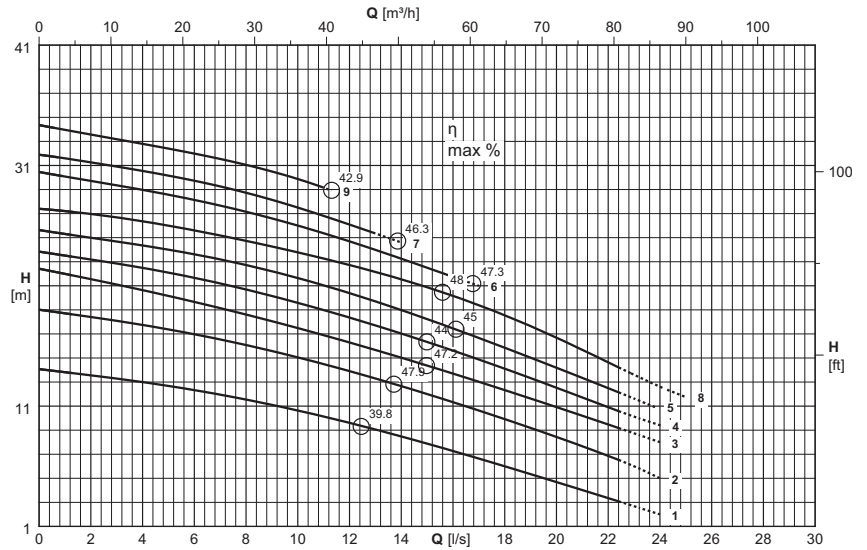

Electric pump type Electropompe type Elettropompa tipo	Curve Courbe Curva	Motor power Puiss. moteur Potenza motore	Capacity Débit Portata													
			[l/s]	0	3	6	9	12	15	18	21	24	27			
	(N°)	[kW]	[m³/h]	0	10,8	21,5	32	43	54	65	76	86	97			
			Head Hauteur Prevalenza													
			[m]	14,1	13,3	12,3	11,1	9,6	7,9	6	4	2				
KKCW080HZ+005522N3	1	5,5	[m]	14,1	13,3	12,3	11,1	9,6	7,9	6	4	2				
KKCW080HX+005522N3	2	5,5	[m]	19	18,1	17	15,6	13,9	12	9,9	7,7	5				
KKCW080HV+005522N3	3	5,5	[m]	22,4	21,1	19,7	18,1	16,3	14,4	12,3	10,2	8				
KKCW080HW+007522N3	4	7,5	[m]	23,8	22,8	21,7	20,1	18,4	16,3	14,1	11,7	9,4				
KKCW080HT+007522N3	5	7,5	[m]	25,6	24,7	23,6	22,2	20,4	18,2	15,8	13,3					
KKCW080HR+007522N3	6	7,5	[m]	30,5	29,3	28,1	26,6	24,7	22,5							
KKCW080HQ+007522N3	7	7,5	[m]	31,9	30,9	29,7	28,1	26,1								
KKCW080HP+007522N3	8	7,5	[m]	27,4	26,7	25,6	24,3	22,7	20,9	18,5	15,7	12,6				
KKCW080HN+007522N3	9	7,5	[m]	34,4	33,2	32	30,5									
NPSH _R			[m]		1	1,1	1,2	1,3	1,5	1,8	2,1					

P₂ = Power rated by the motor

Performance tolerance as per:
UNI/ISO 9906 Grade 3B

For the accessories specification see page "Accessories"

The hatched part of the curve represents the out-of-range of operation.

The impellers will be trimmed to meet the duty point

The performance values refer to units with Caprari motors.

P₂ = Puissance restituée par le moteur

Tolérances sur les performances selon normes:
UNI/ISO 9906 Niveau 3B

Pour les accessoires voir page "Accessories"

La partie pointillée de la courbe indique l'utilisation hors de la plage.

Le point de fonctionnement désiré peut être obtenu par rognage de roue

Les performances se réfèrent à des groupes avec moteurs Caprari.

P₂ = Potenza resa dal motore

Tolleranze sulle prestazioni secondo norme:
UNI/ISO 9906 Grado 3B

Per accessori vedere pagina accessori

La parte tratteggiata della curva rappresenta il fuori campo di utilizzo.

Le giranti vengono tornite in modo da ottenere il punto di lavoro richiesto

Le prestazioni sono riferite a gruppi con motori Caprari.

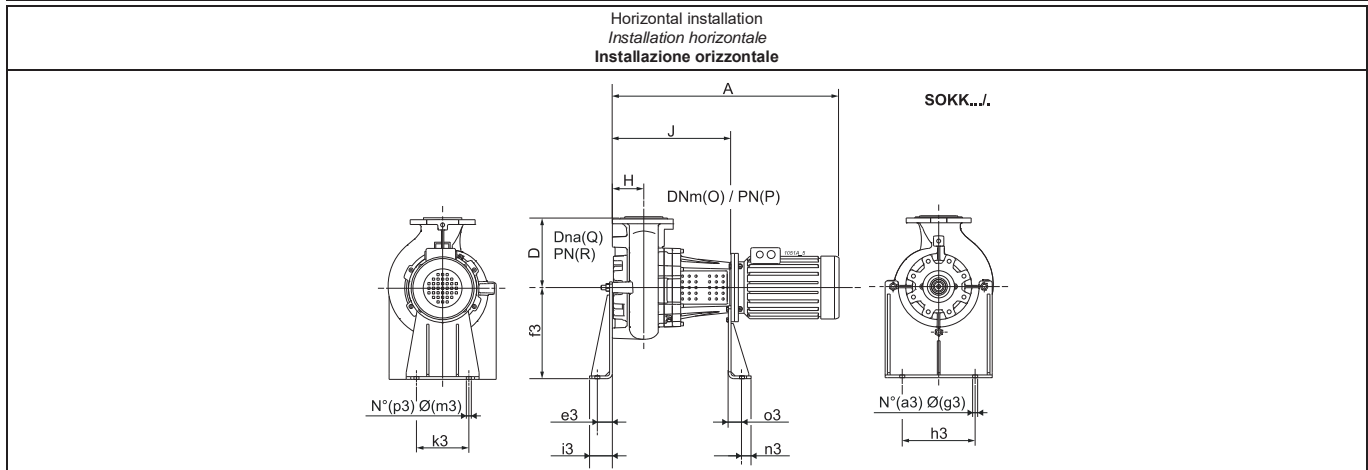
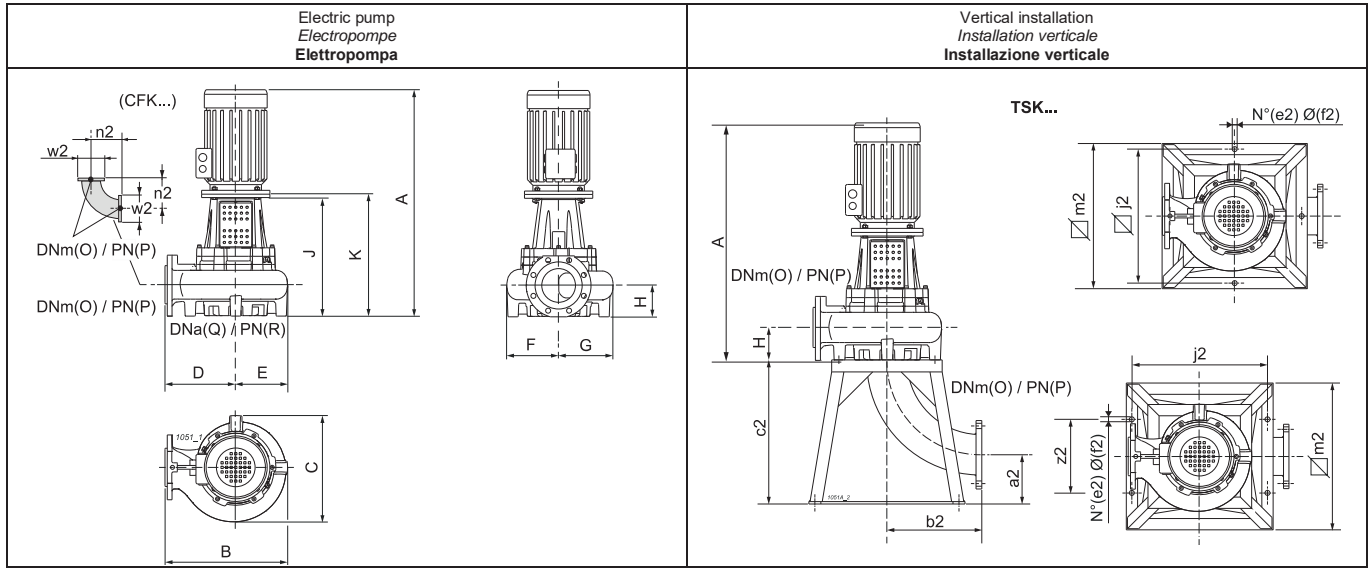

Type Type Tipo	Free passage Passage libre Passaggio Libero	Weight Poids Peso	A	B	C	D	E	F	G	H	J	K	O	P	Q	R	a2	a3	b2
			[mm]	[kg]	[mm]														
KKCW080HZ+005522N3	Ø 80	80	812	391	292	245	146	146	146	92	420	437	80	16	80	16 (*)	126	2	164
KKCW080HX+005522N3	Ø 80	80	812	391	292	245	146	146	146	92	420	437	80	16	80	16 (*)	126	2	164
KKCW080HV+005522N3	Ø 80	80	812	391	292	245	146	146	146	92	420	437	80	16	80	16 (*)	126	2	164
KKCW080HW+007522N3	Ø 80	85	812	391	292	245	146	146	146	92	420	437	80	16	80	16 (*)	126	2	164
KKCW080HT+007522N3	Ø 80	85	812	391	292	245	146	146	146	92	420	437	80	16	80	16 (*)	126	2	164
KKCW080HR+007522N3	Ø 80	85	812	391	292	245	146	146	146	92	420	437	80	16	80	16 (*)	126	2	164
KKCW080HQ+007522N3	Ø 80	85	812	391	292	245	146	146	146	92	420	437	80	16	80	16 (*)	126	2	164
KKCW080HP+007522N3	Ø 80	85	812	391	292	245	146	146	146	92	420	437	80	16	80	16 (*)	126	2	164
KKCW080HN+007522N3	Ø 80	85	812	391	292	245	146	146	146	92	420	437	80	16	80	16 (*)	126	2	164

Type Type Tipo	c2	e2	e3	f2	f3	g3	h3	i3	j2	k3	m2	m3	n2	n3	o3	p3	w2	z2
	[mm]																	
KKCW080HZ+005522N3	290	4	66	12	400	22	270	100	390	230	440	22	164	40	48	2	200	230
KKCW080HX+005522N3	290	4	66	12	400	22	270	100	390	230	440	22	164	40	48	2	200	230
KKCW080HV+005522N3	290	4	66	12	400	22	270	100	390	230	440	22	164	40	48	2	200	230
KKCW080HW+007522N3	290	4	66	12	400	22	270	100	390	230	440	22	164	40	48	2	200	230
KKCW080HT+007522N3	290	4	66	12	400	22	270	100	390	230	440	22	164	40	48	2	200	230
KKCW080HR+007522N3	290	4	66	12	400	22	270	100	390	230	440	22	164	40	48	2	200	230
KKCW080HQ+007522N3	290	4	66	12	400	22	270	100	390	230	440	22	164	40	48	2	200	230
KKCW080HP+007522N3	290	4	66	12	400	22	270	100	390	230	440	22	164	40	48	2	200	230
KKCW080HN+007522N3	290	4	66	12	400	22	270	100	390	230	440	22	164	40	48	2	200	230

For the accessories specification see page "Accessories"
(*) = Consult the flanges page for the flange dimensions.

Pour les accessoires voir page "Accessories"
(*) = Pour les dimensions des brides, voir page brides.

Per accessori vedere pagina accessori
(*) = Per dimensioni flange, vedere pagina flange.

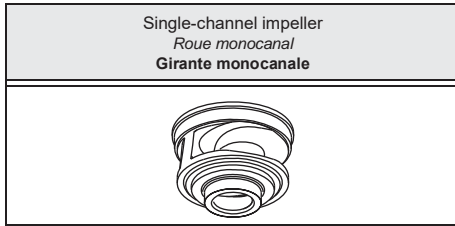

Type Type Tipo	KKCM100H.+...N3	
Conductivity probe Sonde de conductivité Sonda di conduttività	Yes Oui Sì	

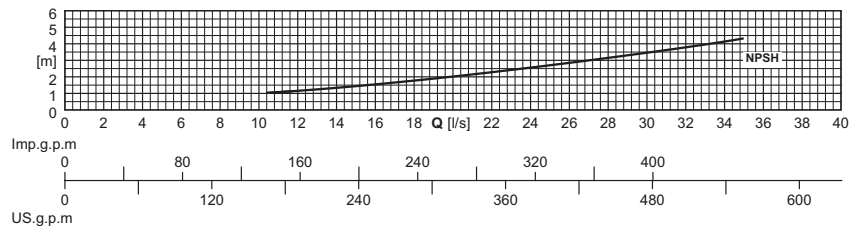
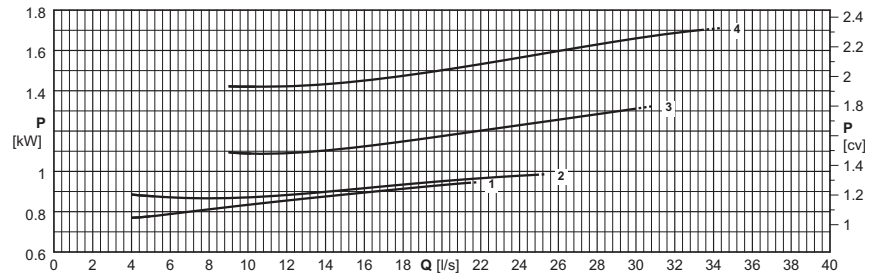
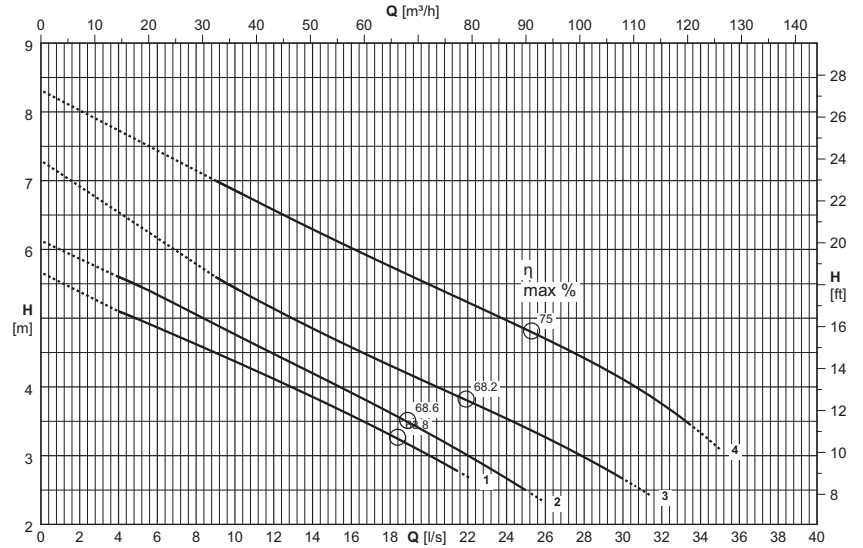

Electric pump type <i>Electropompe type</i> Elettropompa tipo	Curve <i>Courbe</i> Curva	Motor power <i>Puiss. moteur</i> Potenza motore	Capacity <i>Debit</i> Portata													
			[l/s]	0	4	8	12	16	20	24	28	32	36			
		P_2	[m³/h]	0	14,4	29	43	58	72	86	101	115	130			
	(N°)	[kW]	Head <i>Hauteur</i> Prevalenza													
KKCM100HL+001161N3	1	1,1	[m]	5,7	5,1	4,6	4,1	3,6	3							
KKCM100HG+001161N3	2	1,1	[m]	6,1	5,6	5,1	4,5	3,9	3,3	2,7						
KKCM100HD+001561N3	3	1,5	[m]	7,3	-	-	5,1	4,6	4,1	3,5	3					
KKCM100HA+002261N3	4	2,2	[m]	8,3	-	-	6,6	6	5,5	5	4,4	3,8				
NPSH _R			[m]				1,2	1,5	2	2,6	3	3,6				

P_2 = Power rated by the motor

Performance tolerance as per:
UNI/ISO 9906 Grade 3B

For the accessories specification see page "Accessories"

The hatched part of the curve represents the out-of-range of operation.

The performance values refer to units with Caprari motors.

P_2 = Puissance restituée par le moteur

Tolérances sur les performances selon normes:
UNI/ISO 9906 Niveau 3B

Pour les accessoires voir page "Accessories"

La partie pointillée de la courbe indique l'utilisation hors de la plage.

Les performances se réfèrent à des groupes avec moteurs Caprari.

P_2 = Potenza resa dal motore

Tolleranze sulle prestazioni secondo norme:
UNI/ISO 9906 Grado 3B

Per accessori vedere pagina accessori

La parte tratteggiata della curva rappresenta il fuori campo di utilizzo.

Le prestazioni sono riferite a gruppi con motori Caprari.

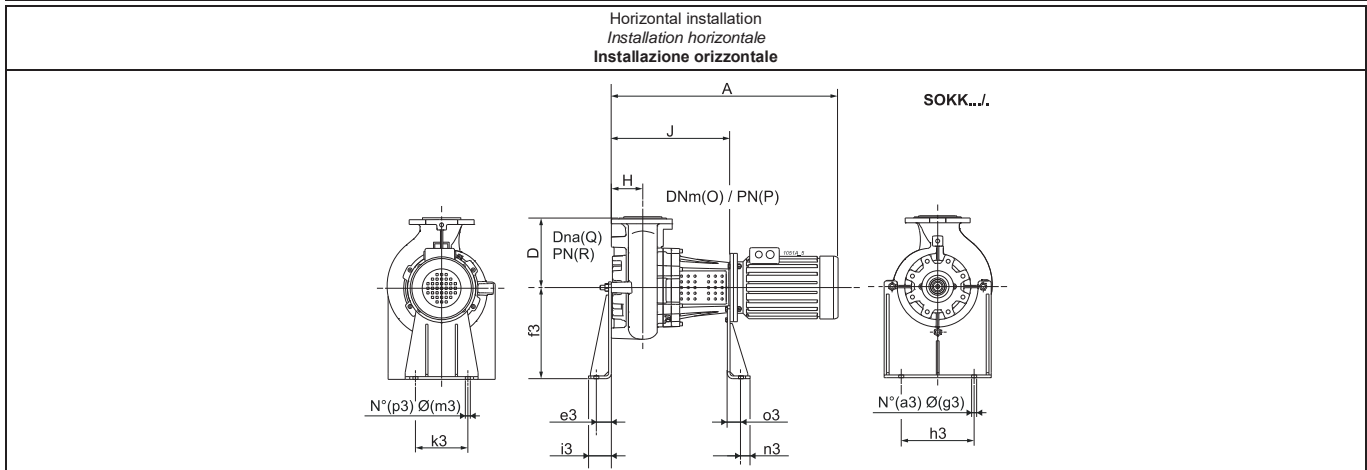
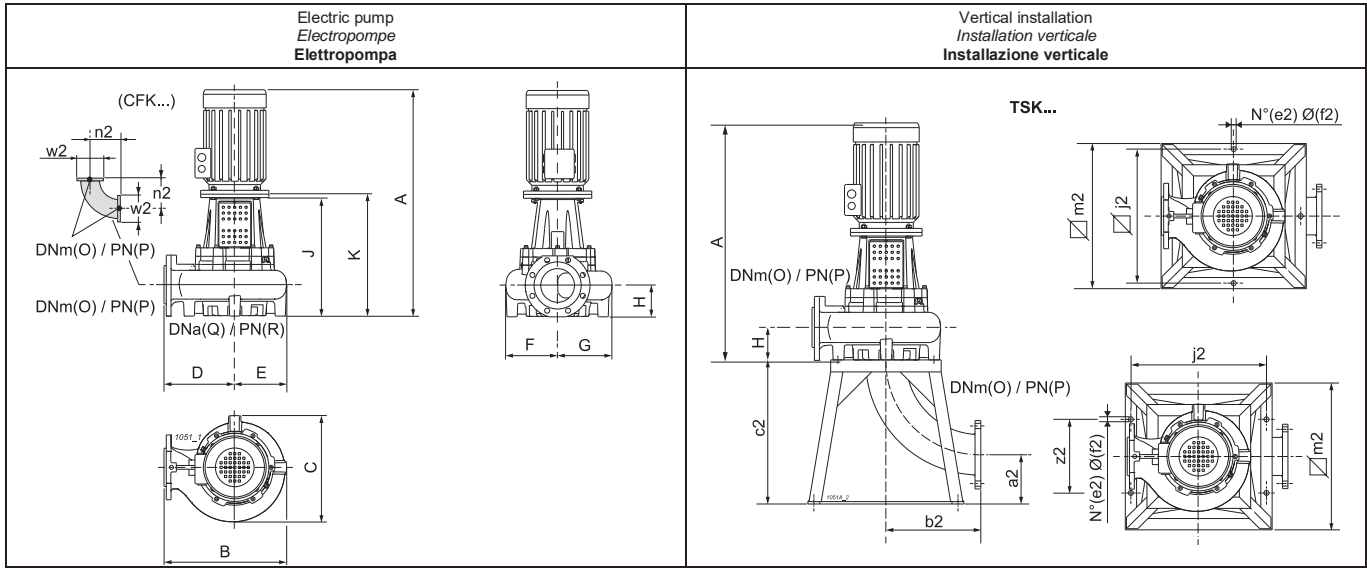

Type Type Tipo	Free passage Passage libre Passaggio Libero	Weight Poids Peso	A	B	C	D	E	F	G	H	J	K	O	P	Q	R	a2	a3	b2
	[mm]		[kg]	[mm]															
KKCM100HL+001161N3	Ø 80	76	762	435	370	255	180	172	198	118	412	427	100	16	100	16	135	2	204
KKCM100HG+001161N3	Ø 80	76	762	435	370	255	180	172	198	118	412	427	100	16	100	16	135	2	204
KKCM100HD+001561N3	Ø 80	84	774	435	370	255	180	172	198	118	412	429	100	16	100	16	135	2	204
KKCM100HA+002261N3	Ø 80	90	809	435	370	255	180	172	198	118	412	429	100	16	100	16	135	2	204
Type Type Tipo	c2	e2	e3	f2	f3	g3	h3	i3	j2	k3	m2	m3	n2	n3	o3	p3	w2	z2	
	[mm]																		
KKCM100HL+001161N3	340	4	66	22	400	22	320	100	600	230	650	22	204	40	48	2	220	600	
KKCM100HG+001161N3	340	4	66	22	400	22	320	100	600	230	650	22	204	40	48	2	220	600	
KKCM100HD+001561N3	340	4	66	22	400	22	320	100	600	230	650	22	204	40	48	2	220	600	
KKCM100HA+002261N3	340	4	66	22	400	22	320	100	600	230	650	22	204	40	48	2	220	600	

For the accessories specification see page "Accessories"

Pour les accessoires voir page "Accessories"

Per accessori vedere pagina accessori

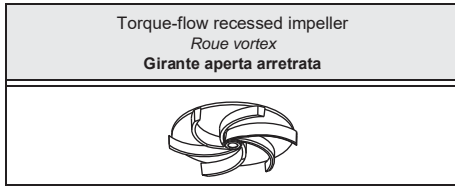

Type Type Tipo	KKCW100H.+...N3	
Conductivity probe Sonde de conductivité Sonda di conduttività	Yes Oui Sì	

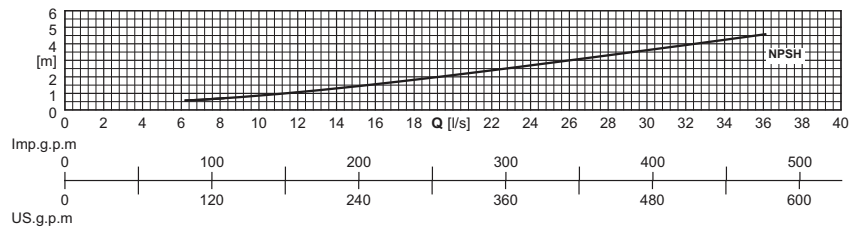
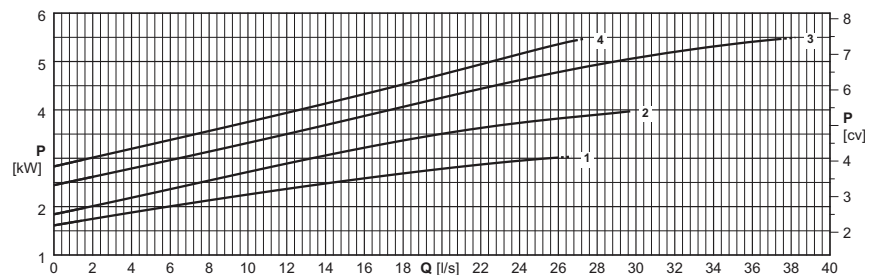
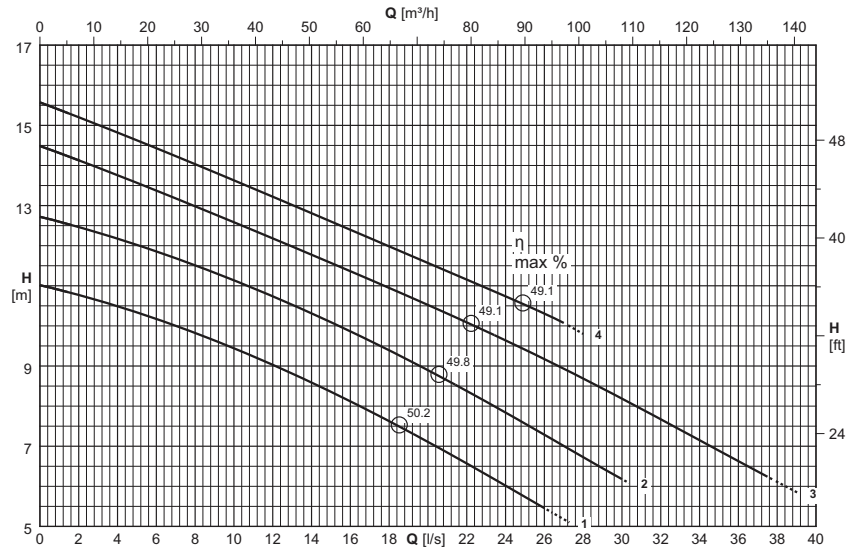

Electric pump type <i>Electropompe type</i> Elettropompa tipo	Curve <i>Courbe</i> Curva	Motor power <i>Puiss. moteur</i> Potenza motore	Capacity <i>Debit</i> Portata														
			[l/s]	0	4	8	12	16	20	24	28	32	36	40			
		P ₂	[m³/h]	0	14,4	29	43	58	72	86	101	115	130	144			
	(N°)	[kW]	Head <i>Hauteur</i> Prevalenza														
KKCW100HG+003041N3	1	3	[m]	11	10,5	9,8	9	8,1	7,1	6							
KKCW100HE+004041N3	2	4	[m]	12,7	12,2	11,5	10,7	9,9	8,9	7,8	6,7						
KKCW100HC+005542N3	3	5,5	[m]	14,5	13,8	13	12,2	11,4	10,5	9,6	8,7	7,7	6,6				
KKCW100HA+005542N3	4	5,5	[m]	15,6	14,8	14	13,2	12,4	11,6	10,7	9,8						
NPSH _R			[m]			0,8	1,3	2	2,1	2,7	3,4	3,8	4,4				

P₂ = Power rated by the motor

Performance tolerance as per:
UNI/ISO 9906 Grade 3B

For the accessories specification see page "Accessories"

The hatched part of the curve represents the out-of-range of operation.

The impellers will be trimmed to meet the duty point

The performance values refer to units with Caprari motors.

P₂ = Puissance restituée par le moteur

Tolérances sur les performances selon normes:
UNI/ISO 9906 Niveau 3B

Pour les accessoires voir page "Accessories"

La partie pointillée de la courbe indique l'utilisation hors de la plage.

Le point de fonctionnement désiré peut être obtenu par rognage de roue

Les performances se réfèrent à des groupes avec moteurs Caprari.

P₂ = Potenza resa dal motore

Tolleranze sulle prestazioni secondo norme:
UNI/ISO 9906 Grado 3B

Per accessori vedere pagina accessori

La parte tratteggiata della curva rappresenta il fuori campo di utilizzo.

Le giranti vengono tornite in modo da ottenere il punto di lavoro richiesto

Le prestazioni sono riferite a gruppi con motori Caprari.

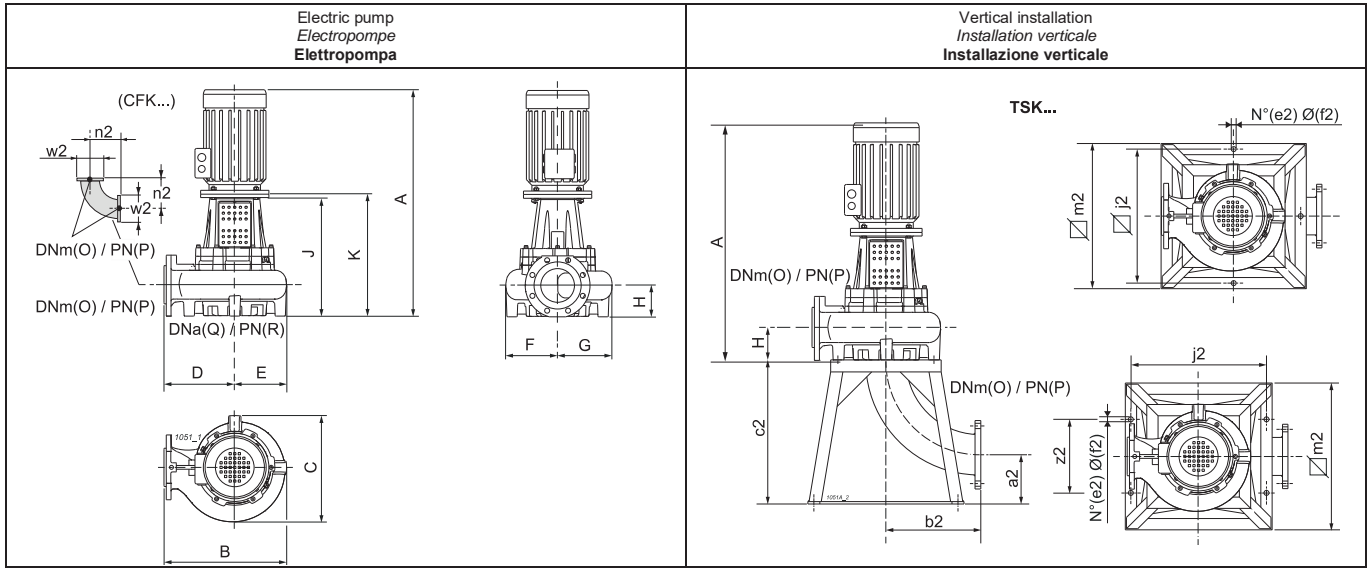

Horizontal installation
Installation horizontale
Installazione orizzontale

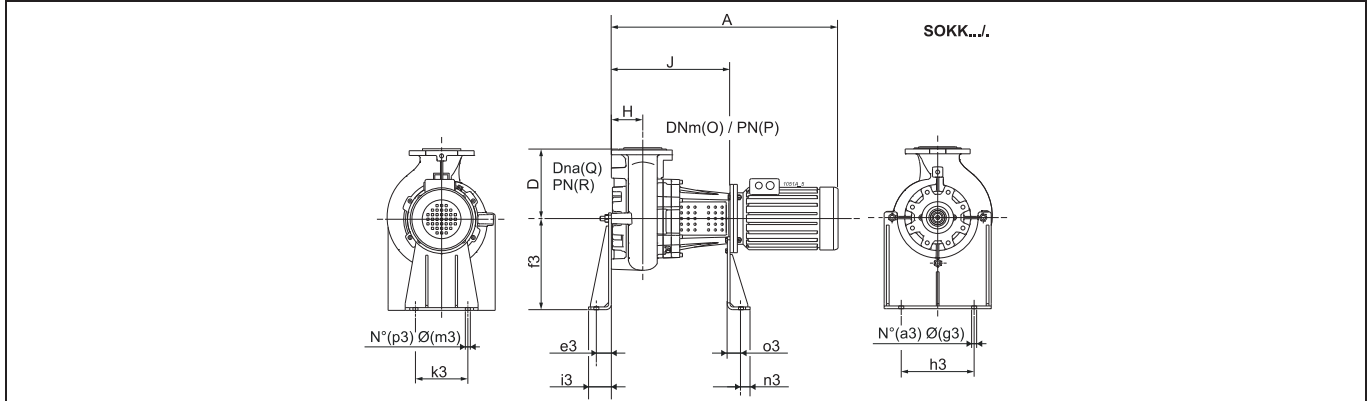

Type Type Tipo	Free passage Passage libre Passaggio Libero	Weight Poids Peso	A	B	C	D	E	F	G	H	J	K	O	P	Q	R	a2	a3	b2
	[mm]		[kg]	[mm]															
KKCW100HG+003041N3	Ø 100	78	792	434	342	263	171	171	171	112	430	447	100	16	100	16	135	2	204
KKCW100HE+004041N3	Ø 100	86	827	434	342	263	171	171	171	112	430	447	100	16	100	16	135	2	204
KKCW100HC+005542N3	Ø 100	94	842	434	342	263	171	171	171	112	450	467	100	16	100	16	135	2	204
KKCW100HA+005542N3	Ø 100	94	842	434	342	263	171	171	171	112	450	467	100	16	100	16	135	2	204
Type Type Tipo	c2	e2	e3	f2	f3	g3	h3	i3	j2	k3	m2	m3	n2	n3	o3	p3	w2	z2	
	[mm]																		
KKCW100HG+003041N3	340	4	66	22	400	22	320	100	600	230	650	22	204	40	48	2	220	600	
KKCW100HE+004041N3	340	4	66	22	400	22	320	100	600	230	650	22	204	40	48	2	220	600	
KKCW100HC+005542N3	340	4	66	22	400	22	320	100	600	230	650	22	204	40	48	2	220	600	
KKCW100HA+005542N3	340	4	66	22	400	22	320	100	600	230	650	22	204	40	48	2	220	600	

For the accessories specification see page "Accessories"

Pour les accessoires voir page "Accessories"

Per accessori vedere pagina accessori

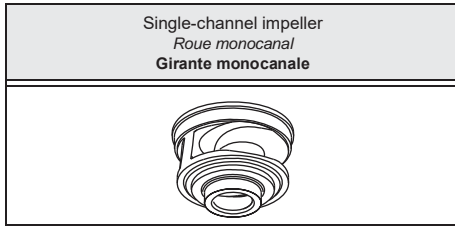

Type Type Tipo	KKCM100H...+...N3	
Conductivity probe Sonde de conductivité Sonda di conduttività	Yes Oui Sì	

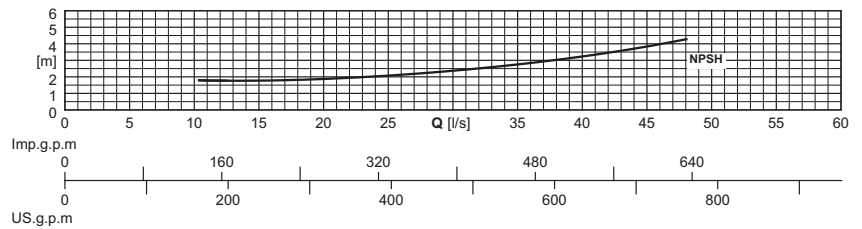
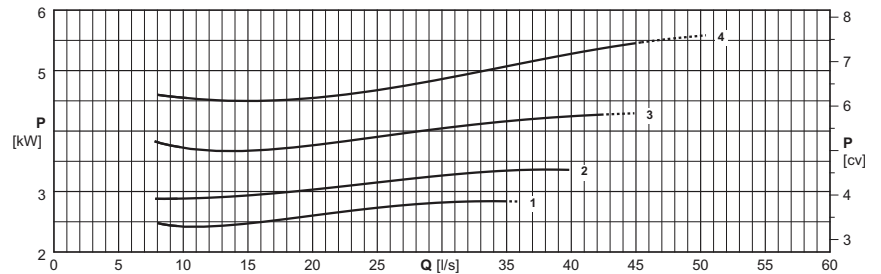
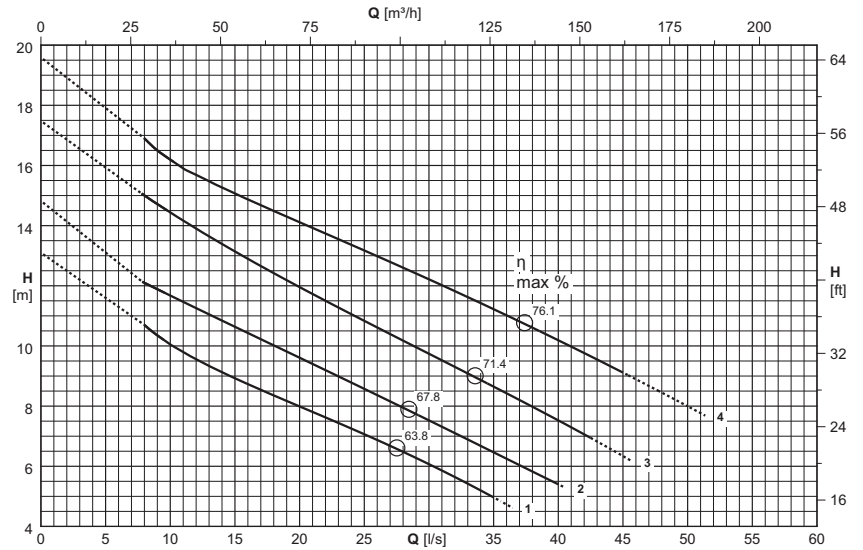

Electric pump type <i>Electropompe type</i> Elettropompa tipo	Curve <i>Courbe</i> Curva	Motor power <i>Puiss. moteur</i> Potenza motore	Capacity <i>Debit</i> Portata													
			[l/s]	0	10	15	20	25	30	35	40	45	50	55		
	(N°)	[kW]	[m³/h]	0	36	54	72	90	108	126	144	162	180	198		
			Head <i>Hauteur</i> Prevalenza													
KKCM100HL+003041N3	1	3	[m]	13,1	10,1	8,9	8	7,1	6,1	5						
KKCM100HG+004041N3	2	4	[m]	14,8	11,7	10,6	9,6	8,6	7,5	6,5	5,4					
KKCM100HD+005542N3	3	5,5	[m]	17,5	14,4	13,1	12	10,8	9,7	8,6	7,5	6,3				
KKCM100HA+005542N3	4	5,5	[m]	19,6	16,2	15,1	14,1	13,2	12,2	11,2	10,2	9,1	8			
NPSH _R			[m]			1,8	1,9	2,1	2,4	3,5	3,2	3,8				

P₂ = Power rated by the motor

Performance tolerance as per:
UNI/ISO 9906 Grade 3B

For the accessories specification see page "Accessories"

The hatched part of the curve represents the out-of-range of operation.

The performance values refer to units with Caprari motors.

P₂ = Puissance restituée par le moteur

Tolérances sur les performances selon normes:
UNI/ISO 9906 Niveau 3B

Pour les accessoires voir page "Accessories"

La partie pointillée de la courbe indique l'utilisation hors de la plage.

Les performances se réfèrent à des groupes avec moteurs Caprari.

P₂ = Potenza resa dal motore

Tolleranze sulle prestazioni secondo norme:
UNI/ISO 9906 Grado 3B

Per accessori vedere pagina accessori

La parte tratteggiata della curva rappresenta il fuori campo di utilizzo.

Le prestazioni sono riferite a gruppi con motori Caprari.

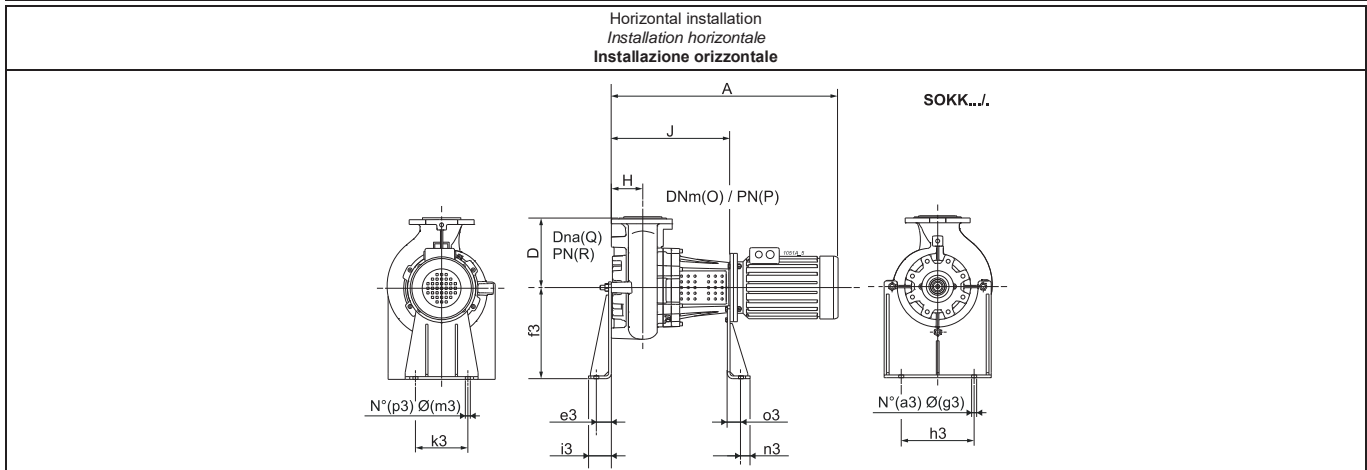
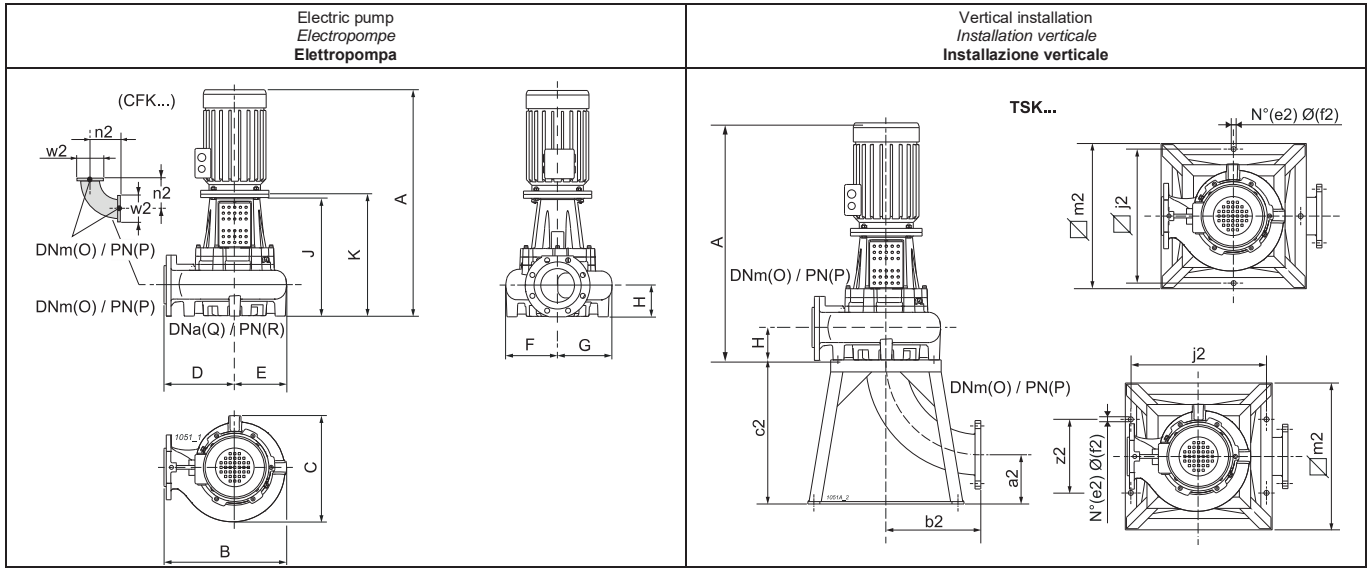

Type Type Tipo	Free passage Passage libre Passaggio Libero	Weight Poids Peso	A	B	C	D	E	F	G	H	J	K	O	P	Q	R	a2	a3	b2
	[mm]		[kg]	[mm]															
KKCM100HL+003041N3	Ø 80	87	774	435	370	255	180	172	198	118	412	429	100	16	100	16	135	2	204
KKCM100HG+004041N3	Ø 80	93	809	435	370	255	180	172	198	118	412	429	100	16	100	16	135	2	204
KKCM100HD+005542N3	Ø 80	108	824	435	370	255	180	172	198	118	432	449	100	16	100	16	135	2	204
KKCM100HA+005542N3	Ø 80	110	824	435	370	255	180	172	198	118	432	449	100	16	100	16	135	2	204
Type Type Tipo	c2	e2	e3	f2	f3	g3	h3	i3	j2	k3	m2	m3	n2	n3	o3	p3	w2	z2	
	[mm]																		
KKCM100HL+003041N3	340	4	66	22	400	22	320	100	600	230	650	22	204	40	48	2	220	600	
KKCM100HG+004041N3	340	4	66	22	400	22	320	100	600	230	650	22	204	40	48	2	220	600	
KKCM100HD+005542N3	340	4	66	22	400	22	320	100	600	230	650	22	204	40	48	2	220	600	
KKCM100HA+005542N3	340	4	66	22	400	22	320	100	600	230	650	22	204	40	48	2	220	600	

For the accessories specification see page "Accessories"

Pour les accessoires voir page "Accessories"

Per accessori vedere pagina accessori

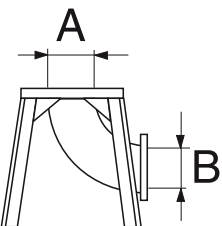
Base frame (dipped galvanized steel) Chassis de soutien (acier galvanisé) Telaio di sostegno (acciaio zincato a caldo)	Type Type Tipo	A		B		Weight Poids Peso [Kg]	Electric pump type Electropompe type Elettropompa tipo						
		DN	UNI PN	DN	UNI PN		KKCW080H	KKCM080H	KKCW100H	KKCM100H			
	TSK100A	100	16	100	16	34	-	I (*)	I	I			
	TSKK80A	80	16	80	16	35	I	I (*)	-	-			

(*) = DNa (Q) = 80
(*) = DNa (Q) = 100

(*) = DNa (Q) = 80
(*) = DNa (Q) = 100

(*) = DNa (Q) = 80
(*) = DNa (Q) = 100

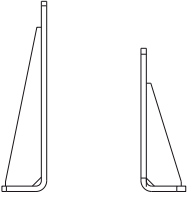
Supports (Steel with protective paint) Support de soutien (Acier revêtu de peinture de protection) Supporti (acciaio con vernice protettiva)	Type Type Tipo	Weight Poids Peso [Kg]	Electric pump type Electropompe type Elettropompa tipo							
			KKCW080H	KKCM080H	KKCW100H	KKCM100H				
	SOKK80/1	33	1,1-1,5	1,1-1,5	-	-				
	SOKK80/2	32	2,2-3	2,2	-	-				
	SOKK80/3	33	5,5-7,5	-	-	-	-			
	SOKK100/1	34,5	-	-	-	1,1				
	SOKK100/2	35,5	-	3-4	3-4	1,5-2,2-3-4				
	SOKK100/3	34	-	5,5	5,5	5,5				

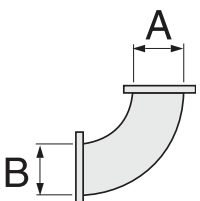
Flanged elbow (dipped galvanized steel) Coude bridé (acier galvanisé à chaud) Curva flangiata (acciaio zincato a caldo)	Type Type Tipo	A		B		Weight Poids Peso [Kg]	Electric pump type Electropompe type Elettropompa tipo					
		DN	UNI PN	DN	UNI PN		KKCW080H	KKCM080H	KKCW100H	KKCM100H		
	CFK80	80	16	80	16	10,5	I	I	-	-		
	CFK100	100	16	100	16	12	-	-	I	I		

Performance ranges
Champs de performance
Campo di prestazione

KKCW080L
KKCM080L
KKCW100L
KKCM150L
KKCM150H
KKCD200N

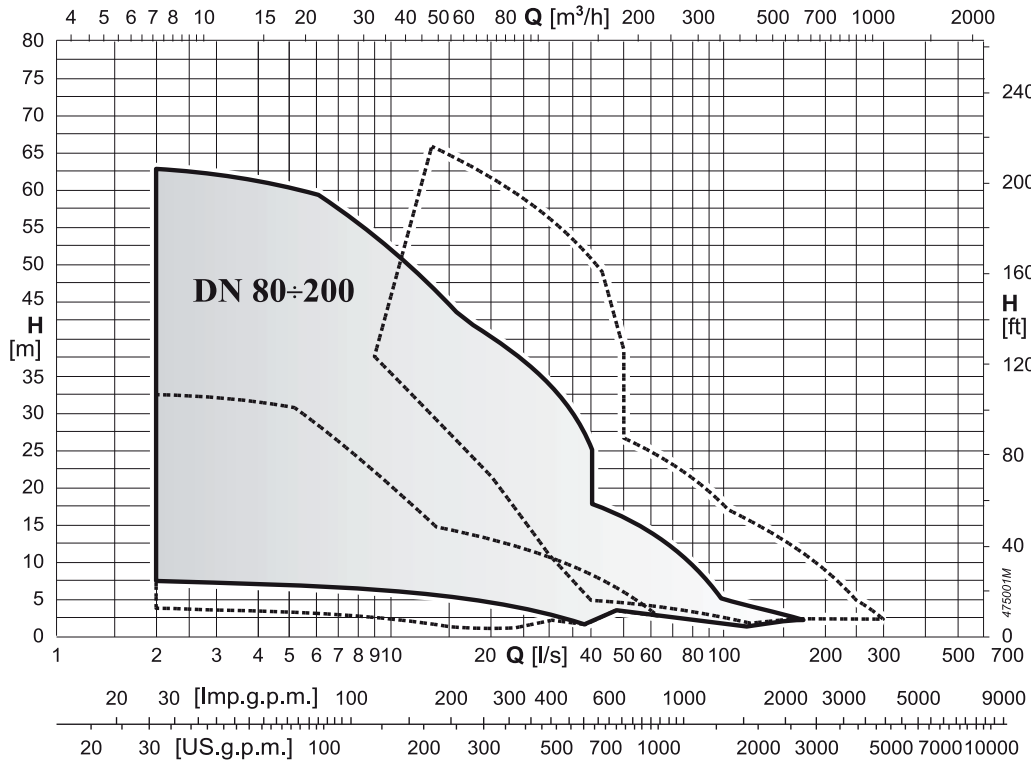

K-Kompact DN 80÷200

caprari

Electric pump coding
Exemplification du sigle de l'électropompe
Esemplificazione sigla elettropompa

KKCW080L
KKCM080L
KKCW100L
KKCM150L
KKCM150H
KKCD200N

Motor code match
Codes communs avec le sigle moteur
Comunanze con sigla motore

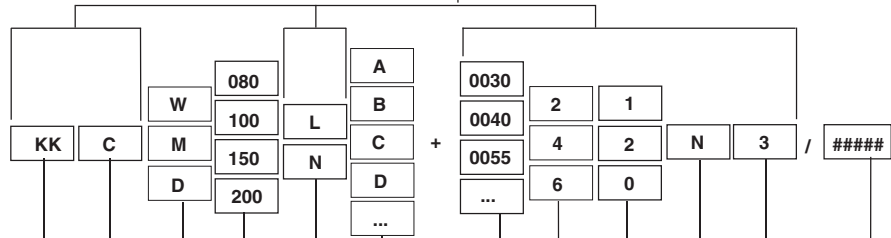

Series - Série - Serie

50 Hz

Impeller: vortex "W"; single-channel "M"; double channel "D"
Roue: vortex "W"; monocanal "M"; à 2 canaux "D"
Girante: a vortice "W"; monocanale "M"; bicanale "D"

Size of pump end (DNm)
Grandeur partie hydraulique (DNm)
Grandezza parte idraulica (DNm)

Size of electric motor flanging
Dimension bride moteur électrique
Grandezza flangiatura motore elettrico

Impeller diameter - Réduction roue - Riduzione girante

Motor output power code
Code puissance rendement moteur
Codice potenza resa motore

Number of poles - Nombre de pôles - Numero poli

Constructional features of electric motor threephase, class F insulation, IP55-IEC protection degree
Caractéristiques de fabrication moteur électrique triphasé, classe d'isolation F, degré de protection IP55-IEC
Caratteristiche costruttive motore elettrico trifase, classe di isolamento F, grado di protezione IP55-IEC
1 = 230 (220-240) V- Δ / 400 (380-415) V-Y
2 = 400 (380-415) V- Δ / 700 (660-720) V-Y 0 = Specials - Spéciaux - Speciali

Standard electric pump: (N) ;
Electropompe standard: (N) ;
Elettropompa standard: (N)

Generational code - Code générationnel - Codice generazionale

Various specialities - Spécialités diverses - Specialità varie

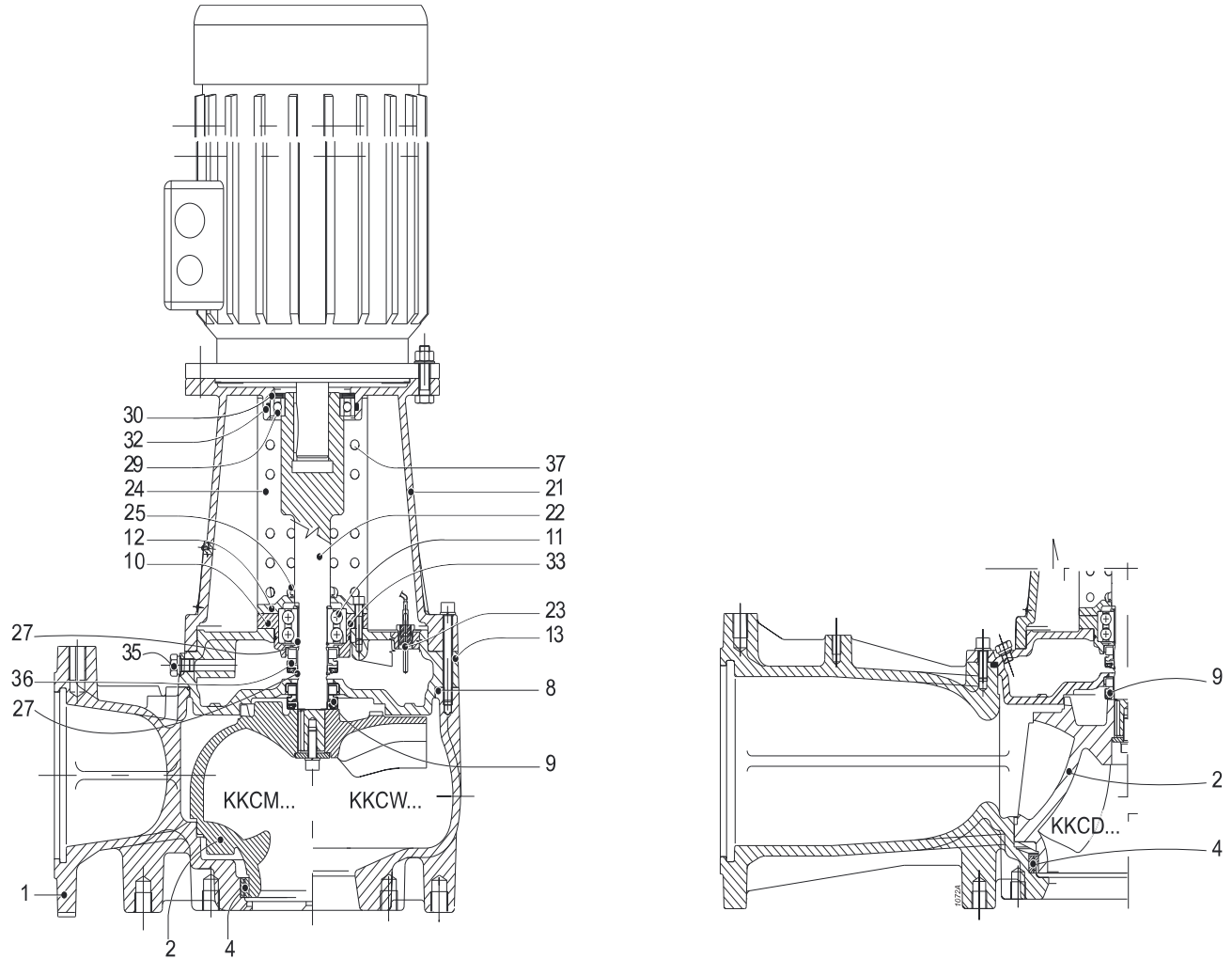

Pos.	Parts	Materials	Nomenclature	Matériaux	Nomenclatura	Materiale
1	Delivery body	Cast iron	Corps de refoulement	Fonte grise	Corpo mandata	Ghisa grigia
2	Impeller	Cast iron	Roue	Fonte grise	Girante	Ghisa grigia
4	Wear ring	Steel/Rubber	Bague d'usure	Acier/Caoutchouc	Anello sede girante	Acciaio/Gomma
8 - 32 - 33	Seal ring	Rubber	Bague d'étanchéité	Caoutchouc	Anello di tenuta OR	Gomma
9	Mechanical seal on pump side	Ceramic/graphite	Garniture mécanique côté pompe	Céramique/graphite	Tenuta meccanica lato pompa	Ceramica/grafite
10	Bearing support	Nodular cast iron	Support de roulement	Fonte sphéroidale	Supporto cuscinetto	Ghisa sferoidale
11 - 29	bearing	-	roulement	-	Cuscinetto	-
12	Flange bearing	Cast iron	Bride roulement	Fonte grise	Flangia cuscinetto	Ghisa grigia
13	Oil box	Cast iron	Chambre à huile	Fonte grise	Scatola olio	Ghisa grigia
21	Lantern bracket	Cast iron	Lanterne support	Fonte grise	Supporto di collegamento	Ghisa grigia
22	Pump shaft	Stainless steel	Arbre de pompe	Acier inox	Albero pompa	Acciaio inox
23	Conductivity probe	Brass	Sondes de conductivité	Laiton	Sonda di conduttività	Ottone
24	Protective casing	Stainless steel	Carter de protection	Acier inox	Carter di protezione	Acciaio inox
25	Seal ring	Rubber	Bague d'étanchéité	Caoutchouc	Anello di tenuta	Gomma
27	Elastic ring	Steel	Circlip	Acier	Anello elastico	Acciaio
30	Belleville washer	Stainless steel	Rondelle Belleville	Acier inox	Molla a tazza	Acciaio inox
35	Plug	Stainless steel	Bouchon	Acier inox	Tappo	Acciaio inox
36	Mechanical seal on motor side	Ceramic/graphite	Garniture mécanique côté moteur	Céramique/graphite	Tenuta meccanica lato motore	Ceramica/grafite
37	Probe holder	Rubber	Porte-sonde	Caoutchouc	Porta sondino	Gomma

Screws and nuts in stainless steel.
Sondivity probe in the motor casing

Vis et écrous en acier inox.
Sonde de conductivité dans l'enveloppe du moteur

Viti e dadi in acciaio inox.
Sonda di conduttività nella carcassa motore

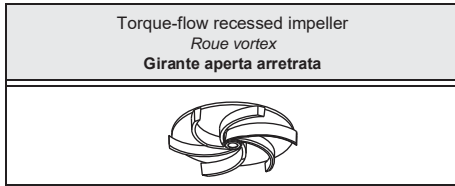

Type Type Tipo	KKCW080L...+...N3	
Conductivity probe Sonde de conductivité Sonda di conduttività	Yes Oui Sì	

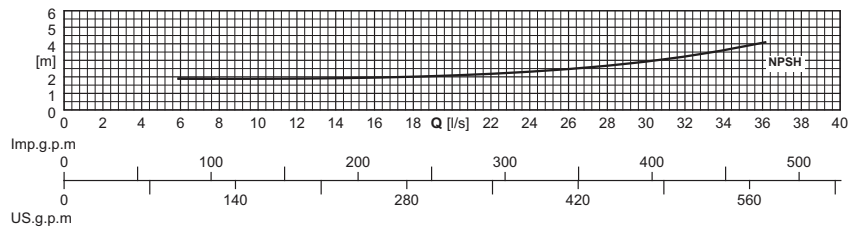
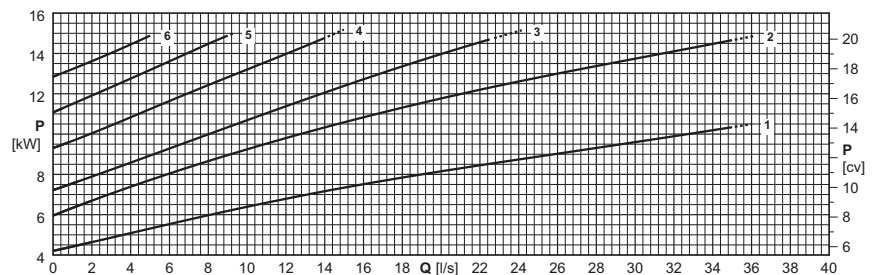
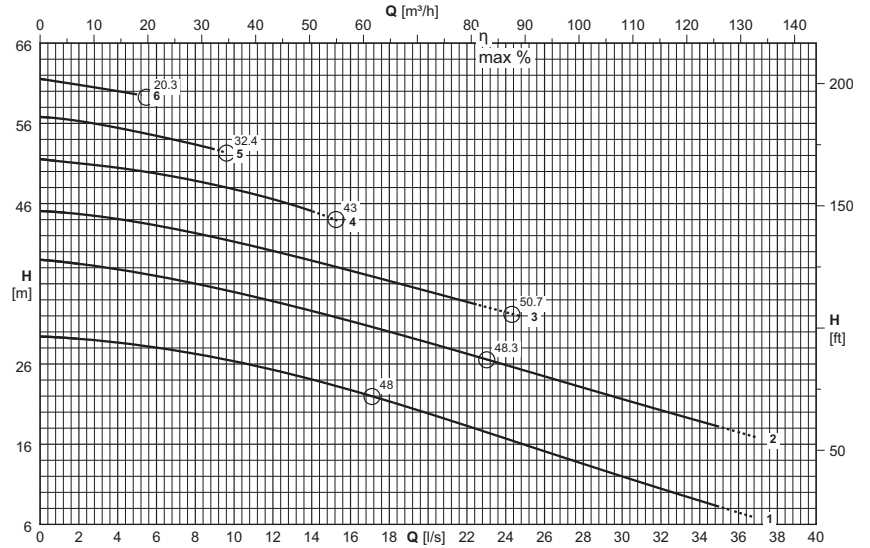

Electric pump type Electropompe type Elettropompa tipo	Curve Courbe Curva	Motor power Puiss. moteur Potenza motore	Capacity Debit Portata														
			[l/s]	0	4	8	12	16	20	24	28	32	36	40			
		P ₂	[m³/h]	0	14,4	29	43	58	72	86	101	115	130	144			
	(N°)	[kW]	Head Hauteur Prevalenza														
KKCW080LR+011022N3	1	11	[m]	29,4	28,7	27,3	25,3	22,7	19,8	16,7	13,5	10,5	7,5				
KKCW080LP+015022N3	2	15	[m]	39	37,8	36	33,8	31,3	28,7	25,9	23	20,2	17,5				
KKCW080LL+015022N3	3	15	[m]	45,1	44,1	42,3	40,1	37,6	35,1	32,5							
KKCW080LG+015022N3	4	15	[m]	51,6	50,5	48,8	46,5										
KKCW080LD+015022N3	5	15	[m]	56,8	55,4	53,4											
KKCW080LA+015022N3	6	15	[m]	61,5	60												
NPSH _R			[m]			1,9	1,9	2	2,1	2,3	2,7	3,2	4,1				

P₂ = Power rated by the motor
Performance tolerance as per:
UNI/ISO 9906 Grade 3B
For the accessories specification see page "Accessories"
The hatched part of the curve represents the out-of-range of operation.
The impellers will be trimmed to meet the duty point
The performance values refer to units with Caprari motors.

P₂ = Puissance restituée par le moteur
Tolérances sur les performances selon normes:
UNI/ISO 9906 Niveau 3B
Pour les accessoires voir page "Accessories"
La partie en pointillé de la courbe indique l'utilisation hors de la plage.
Le point de fonctionnement désiré peut être obtenu par rognage de roue
Les performances se réfèrent à des groupes avec moteurs Caprari.

P₂ = Potenza resa dal motore
Tolleranze sulle prestazioni secondo norme:
UNI/ISO 9906 Grado 3B
Per accessori vedere pagina accessori
La parte tratteggiata della curva rappresenta il fuori campo di utilizzo.
Le giranti vengono tornite in modo da ottenere il punto di lavoro richiesto
Le prestazioni sono riferite a gruppi con motori Caprari.

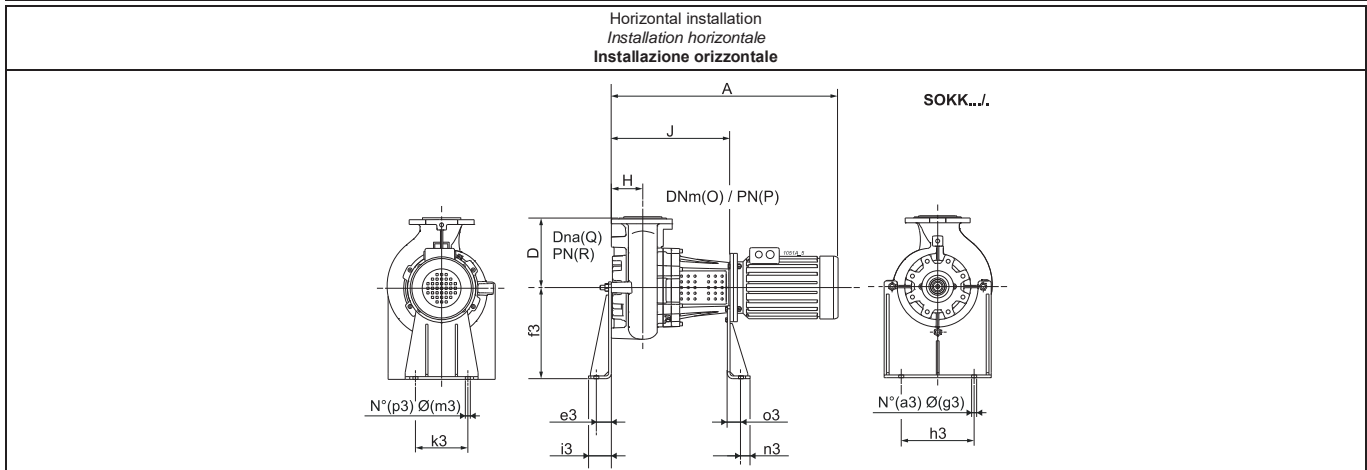
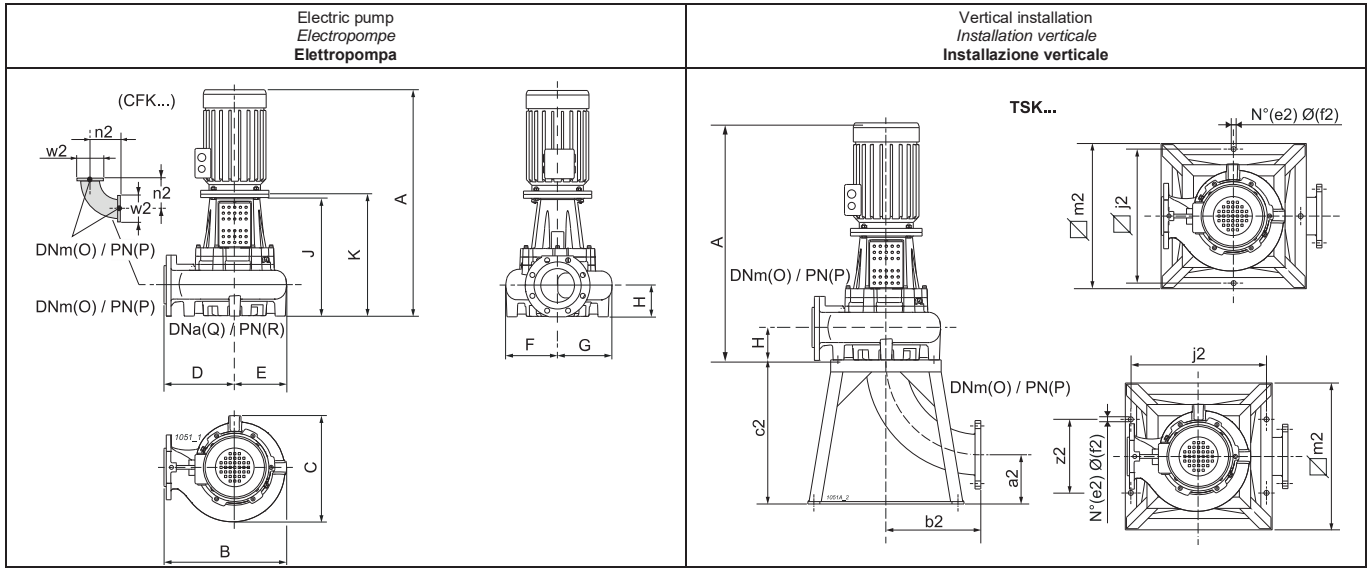

Type Type Tipo	Free passage Passage libre Passaggio Libero	Weight Poids Peso	A	B	C	D	E	F	G	H	J	K	O	P	Q	R	a2	a3	b2
			[mm]	[kg]	[mm]														
KKCW080LR+011022N3	Ø 80	135	1105	543	330	370	173	165	165	102	518	535	80	16	80	16 (*)	126	2	164
KKCW080LP+015022N3	Ø 80	145	1105	543	330	370	173	165	165	102	518	535	80	16	80	16 (*)	126	2	164
KKCW080LL+015022N3	Ø 80	145	1105	543	330	370	173	165	165	102	518	535	80	16	80	16 (*)	126	2	164
KKCW080LG+015022N3	Ø 80	146	1105	543	330	370	173	165	165	102	518	535	80	16	80	16 (*)	126	2	164
KKCW080LD+015022N3	Ø 80	146	1105	543	330	370	173	165	165	102	518	535	80	16	80	16 (*)	126	2	164
KKCW080LA+015022N3	Ø 80	147	1105	543	330	370	173	165	165	102	518	535	80	16	80	16 (*)	126	2	164

Type Type Tipo	c2	e2	e3	f2	f3	g3	h3	i3	j2	k3	m2	m3	n2	n3	o3	p3	w2	z2
	[mm]																	
KKCW080LR+011022N3	290	4	66	12	400	22	270	100	390	230	440	22	164	40	48	2	200	230
KKCW080LP+015022N3	290	4	66	12	400	22	270	100	390	230	440	22	164	40	48	2	200	230
KKCW080LL+015022N3	290	4	66	12	400	22	270	100	390	230	440	22	164	40	48	2	200	230
KKCW080LG+015022N3	290	4	66	12	400	22	270	100	390	230	440	22	164	40	48	2	200	230
KKCW080LD+015022N3	290	4	66	12	400	22	270	100	390	230	440	22	164	40	48	2	200	230
KKCW080LA+015022N3	290	4	66	12	400	22	270	100	390	230	440	22	164	40	48	2	200	230

For the accessories specification see page "Accessories"
 (*) = Consult the flanges page for the flange dimensions.

Pour les accessoires voir page "Accessories"
 (*) = Pour les dimensions des brides, voir page brides.

Per accessori vedere pagina accessori
 (*) = Per dimensioni flange, vedere pagina flange.

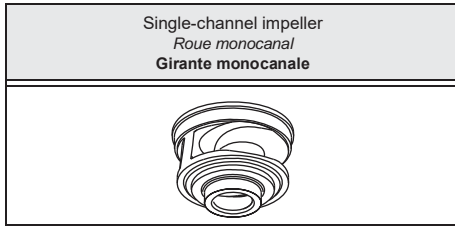

Type Type Tipo	KKCM080L...+...N3	
Conductivity probe Sonde de conductivité Sonda di conduttività	Yes Oui Sì	

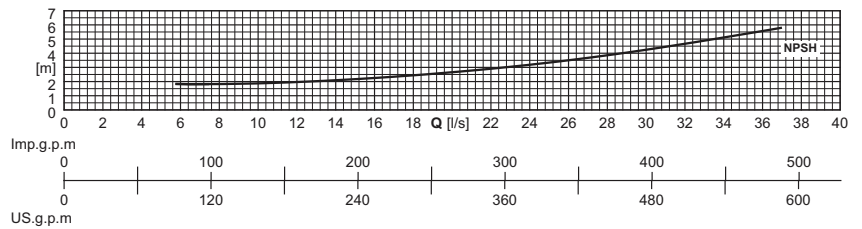
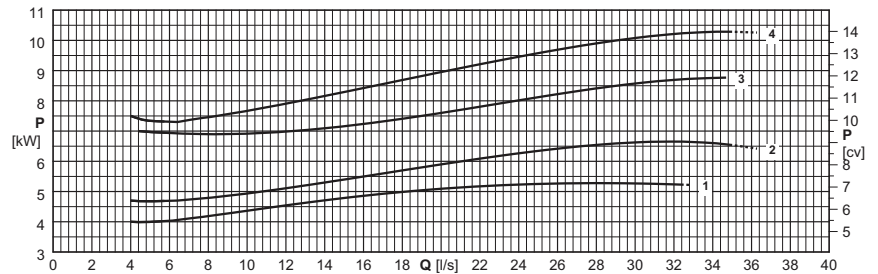
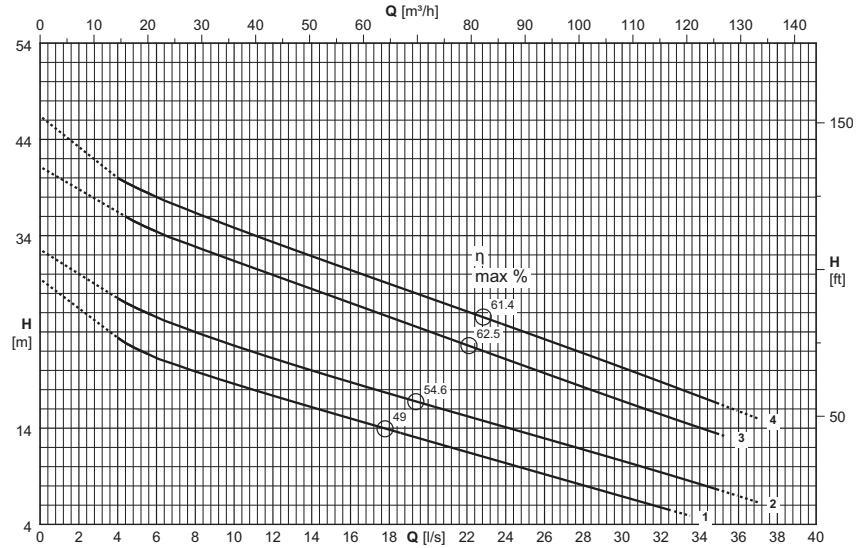

Electric pump type Electropompe type Elettropompa tipo	Curve Courbe Curva	Motor power Puiss. moteur Potenza motore	Capacity Debit Portata														
			[l/s]	0	4	8	12	16	20	24	28	32	36	40			
		P ₂	[m³/h]	0	14,4	29	43	58	72	86	101	115	130	144			
	(N°)	[kW]	Head Hauteur Prevalenza														
KKCM080LI+005522N3	1	5,5	[m]	29,5	23,4	19,9	17,4	15	12,7	10,4	8,1	5,8					
KKCM080LG+007522N3	2	7,5	[m]	32,6	27,5	24	21,3	18,8	16,4	14,1	11,8	9,4	6,9				
KKCM080LE+011022N3	3	11	[m]	41,2	-	32,9	29,9	27	24,1	21,2	18,3	15,4					
KKCM080LC+011022N3	4	11	[m]	46,4	40	36,4	33,3	30,4	27,6	24,7	21,8	18,8	15,8				
NPSH _R			[m]			1,8	2	2,3	2,7	3,2	4	4,7	5,5				

P₂ = Power rated by the motor
Performance tolerance as per:
UNI/ISO 9906 Grade 3B
For the accessories specification see page "Accessories"
The hatched part of the curve represents the out-of-range of operation.
The performance values refer to units with Caprari motors.

P₂ = Puissance restituée par le moteur
Tolérances sur les performances selon normes:
UNI/ISO 9906 Niveau 3B
Pour les accessoires voir page "Accessories"
La partie pointillée de la courbe indique l'utilisation hors de la plage.
Les performances se réfèrent à des groupes avec moteurs Caprari.

P₂ = Potenza resa dal motore
Tolleranze sulle prestazioni secondo norme:
UNI/ISO 9906 Grado 3B
Per accessori vedere pagina accessori
La parte tratteggiata della curva rappresenta il fuori campo di utilizzo.
Le prestazioni sono riferite a gruppi con motori Caprari.

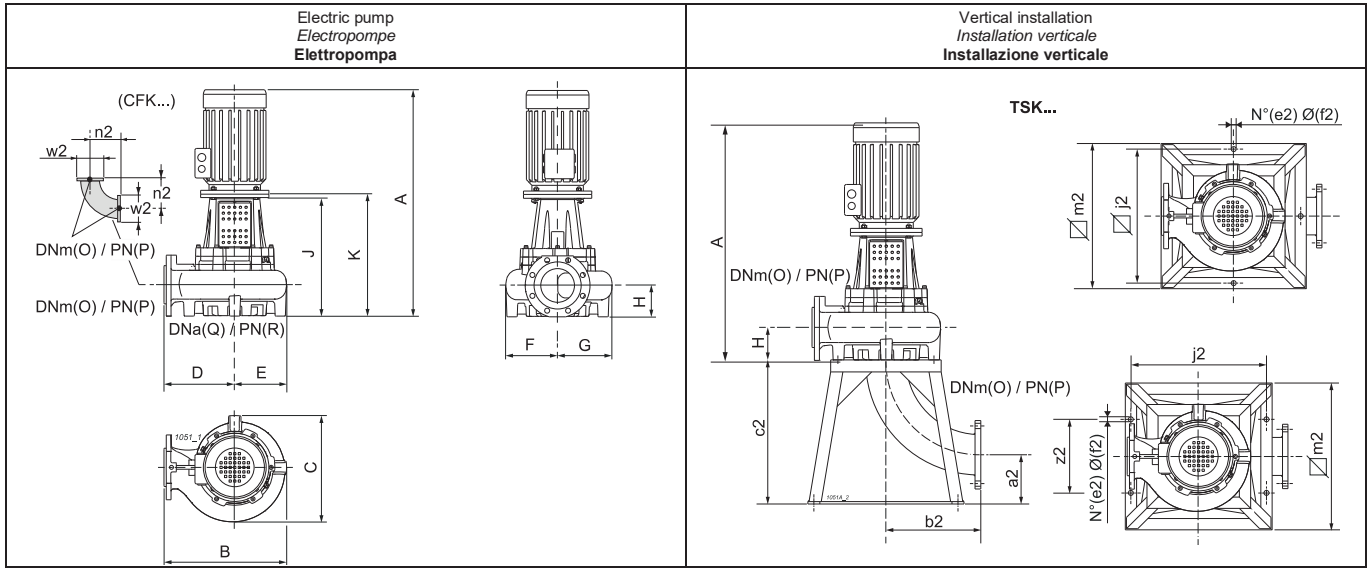

Horizontal installation
Installation horizontale
Installazione orizzontale

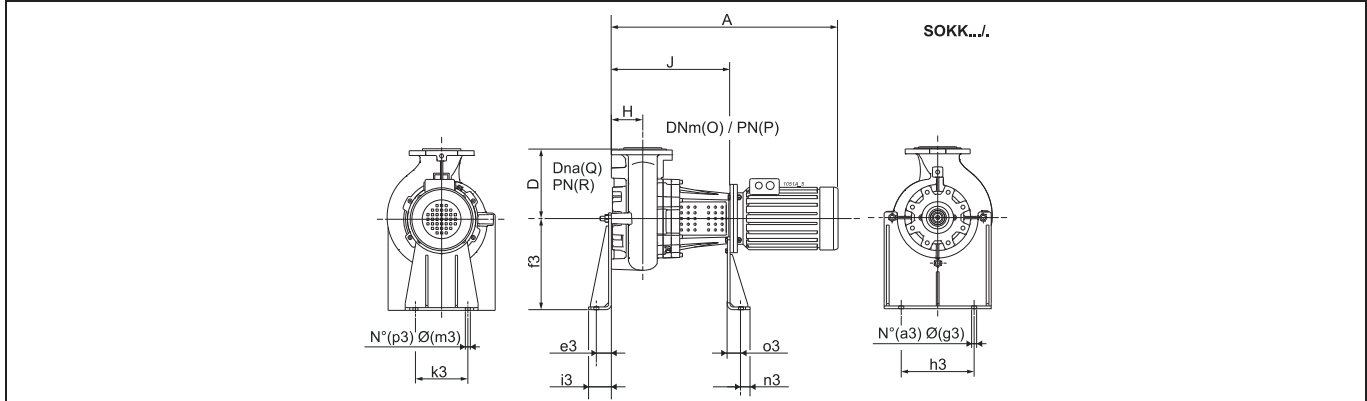

Type Type Tipo	Free passage Passage libre Passaggio Libero	Weight Poids Peso	A	B	C	D	E	F	G	H	J	K	O	P	Q	R	a2	a3	b2
	[mm]		[kg]	[mm]															
KKCM080LI+005522N3	Ø 55	122	868	498	338	325	173	158	180	95	476	493	80	16	80	16 (*)	126	2	164
KKCM080LG+007522N3	Ø 55	128	868	498	338	325	173	158	180	95	476	493	80	16	80	16 (*)	126	2	164
KKCM080LE+011022N3	Ø 55	145	1093	498	338	325	173	158	180	95	506	523	80	16	80	16 (*)	126	2	164
KKCM080LC+011022N3	Ø 55	145	1093	498	338	325	173	158	180	95	506	523	80	16	80	16 (*)	126	2	164
Type Type Tipo	c2	e2	e3	f2	f3	g3	h3	i3	j2	k3	m2	m3	n2	n3	o3	p3	w2	z2	
	[mm]																		
KKCM080LI+005522N3	290	4	66	12	400	22	270	100	390	230	440	22	164	40	48	2	200	230	
KKCM080LG+007522N3	290	4	66	12	400	22	270	100	390	230	440	22	164	40	48	2	200	230	
KKCM080LE+011022N3	290	4	66	12	400	22	270	100	390	230	440	22	164	40	48	2	200	230	
KKCM080LC+011022N3	290	4	66	12	400	22	270	100	390	230	440	22	164	40	48	2	200	230	

For the accessories specification see page "Accessories"
(*) = Consult the flanges page for the flange dimensions.

Pour les accessoires voir page "Accessories"
(*) = Pour les dimensions des brides, voir page brides.

Per accessori vedere pagina accessori
(*) = Per dimensioni flange, vedere pagina flange.

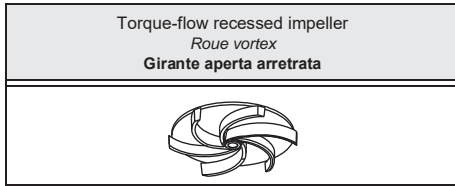

Type Type Tipo	KKCW100L+...N3	
Conductivity probe Sonde de conductivité Sonda di conduttività	Yes Oui Sì	

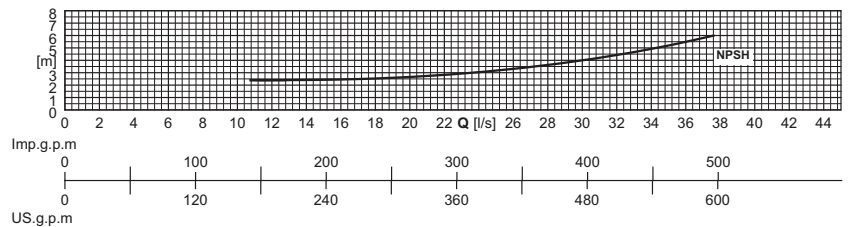
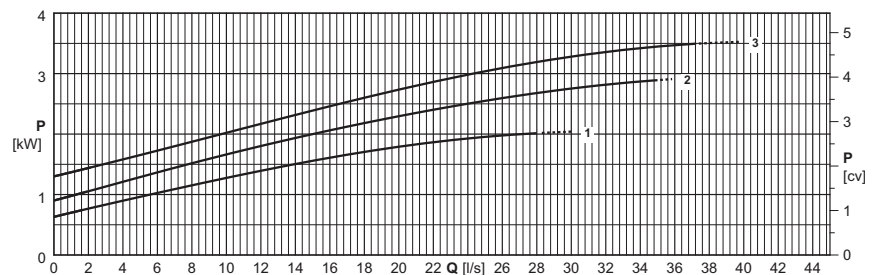
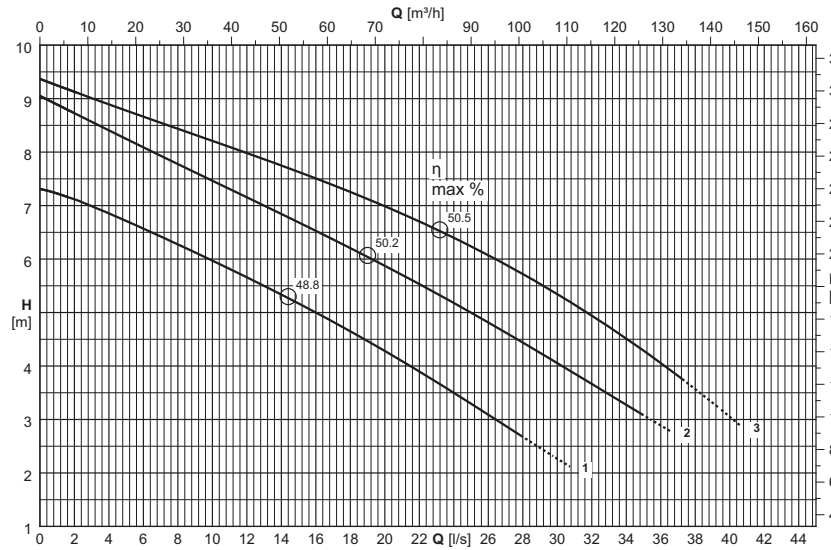

Electric pump type <i>Electropompe type</i> Elettropompa tipo	Curve <i>Courbe</i> Curva	Motor power <i>Puiss. moteur</i> Potenza motore	Capacity <i>Debit</i> Portata														
			[l/s]	0	4	8	12	16	20	24	28	32	36	40	44		
		P_2	[m³/h]	0	14,4	29	43	58	72	86	101	115	130	144	158		
	(N°)	[kW]	Head <i>Hauteur</i> Prevalenza														
KKCW100LE+003061N3	1	3	[m]	7,3	6,9	6,3	5,7	5	4,3	3,5	2,7						
KKCW100LB+003061N3	2	3	[m]	9,1	8,4	7,8	7,2	6,5	5,9	5,2	4,4	3,7	2,9				
KKCW100LA+004061N3	3	4	[m]	9,4	8,9	8,4	8	7,5	7	6,4	5,7	4,9	4,1	3			
NPSH_R			[m]				2,4	2,5	2,7	3	3,6	4,7	5,2				

P_2 = Power rated by the motor

Performance tolerance as per:
UNI/ISO 9906 Grade 3B

For the accessories specification see page "Accessories"

The hatched part of the curve represents the out-of-range of operation.

The impellers will be trimmed to meet the duty point

The performance values refer to units with Caprari motors.

P_2 = Puissance restituée par le moteur

Tolérances sur les performances selon normes:
UNI/ISO 9906 Niveau 3B

Pour les accessoires voir page "Accessories"

La partie pointillée de la courbe indique l'utilisation hors de la plage.

Le point de fonctionnement désiré peut être obtenu par rognage de roue

Les performances se réfèrent à des groupes avec moteurs Caprari.

P_2 = Potenza resa dal motore

Tolleranze sulle prestazioni secondo norme:
UNI/ISO 9906 Grado 3B

Per accessori vedere pagina accessori

La parte tratteggiata della curva rappresenta il fuori campo di utilizzo.

Le giranti vengono tornite in modo da ottenere il punto di lavoro richiesto

Le prestazioni sono riferite a gruppi con motori Caprari.

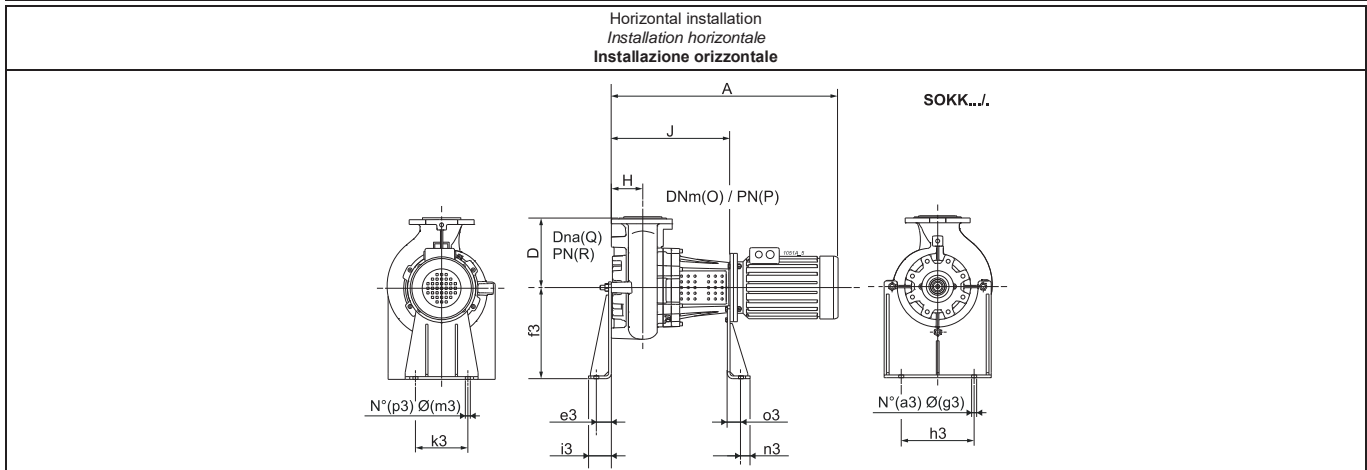
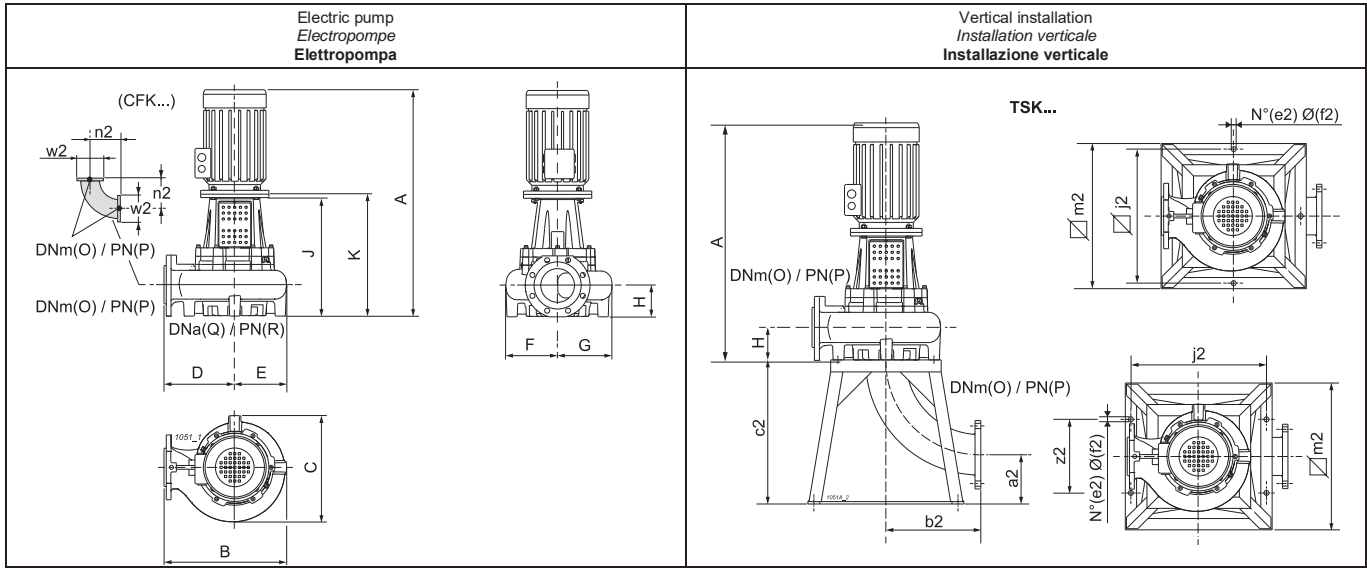

Type Type Tipo	Free passage Passage libre Passaggio Libero	Weight Poids Peso	A	B	C	D	E	F	G	H	J	K	O	P	Q	R	a2	a3	b2
			[mm]	[kg]	[mm]														
KKCW100LE+003061N3	Ø 100	121	903	470	350	295	175	175	175	112	511	528	100	16	100	16	135	2	204
KKCW100LB+003061N3	Ø 100	122	903	470	350	295	175	175	175	112	511	528	100	16	100	16	135	2	204
KKCW100LA+004061N3	Ø 100	129	938	470	350	295	175	175	175	112	511	528	100	16	100	16	135	2	204
Type Type Tipo	c2	e2	e3	f2	f3	g3	h3	i3	j2	k3	m2	m3	n2	n3	o3	p3	w2	z2	
	[mm]																		
KKCW100LE+003061N3	340	4	66	22	400	22	320	100	600	230	650	22	204	40	48	2	220	600	
KKCW100LB+003061N3	340	4	66	22	400	22	320	100	600	230	650	22	204	40	48	2	220	600	
KKCW100LA+004061N3	340	4	66	22	400	22	320	100	600	230	650	22	204	40	48	2	220	600	

For the accessories specification see page "Accessories"

Pour les accessoires voir page "Accessories"

Per accessori vedere pagina accessori

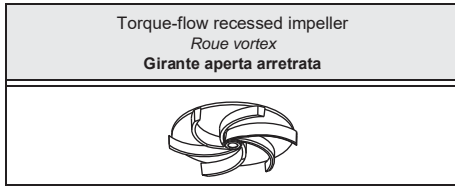

Type Type Tipo	KKCW100L...+...N3	
Conductivity probe Sonde de conductivité Sonda di conduttività	Yes Oui Sì	

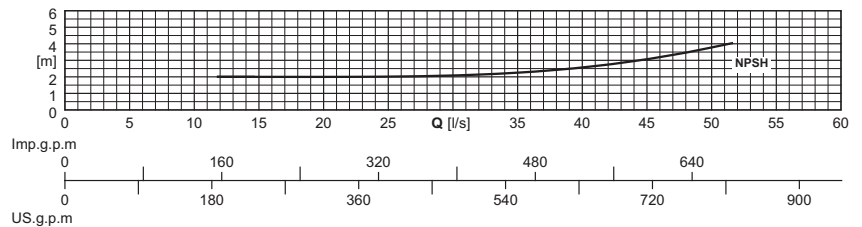
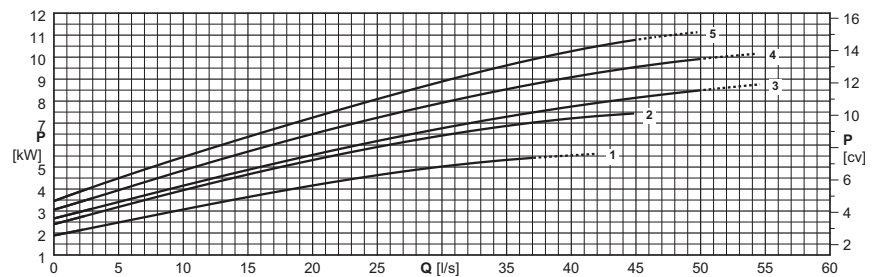
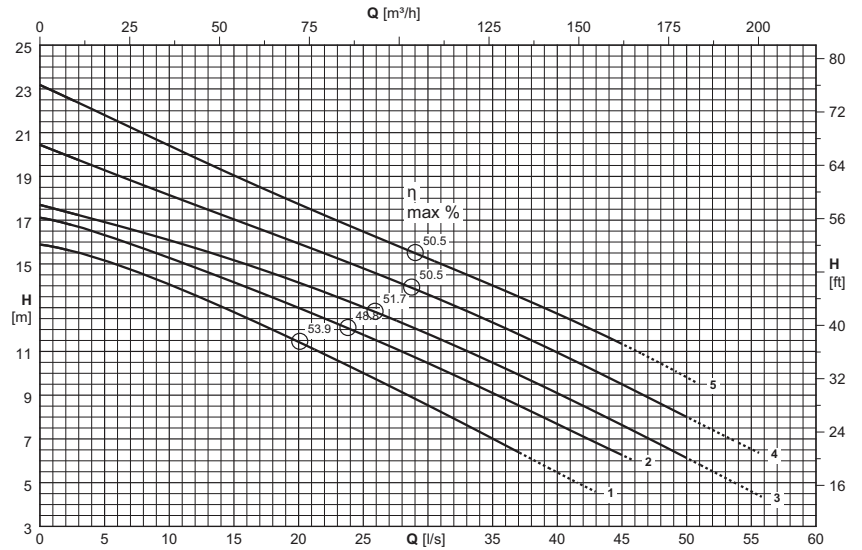

Electric pump type <i>Electropompe type</i> Elettropompa tipo	Curve <i>Courbe</i> Curva	Motor power <i>Puiss. moteur</i> Potenza motore	Capacity <i>Debit</i> Portata											
			[l/s]	0	6	12	18	24	30	36	42	48	54	60
		P ₂	[m³/h]	0	21,5	43	65	86	108	130	151	173	194	216
	(N°)	[kW]	Head <i>Hauteur</i> Prevalenza											
KKCW100LG+005542N3	1	5,5	[m]	15,9	14,9	13,6	12	10,3	8,5	6,7	4,9			
KKCW100LD+007542N3	2	7,5	[m]	17,1	16,1	14,8	13,5	12	10,5	8,8	7,1			
KKCW100LC+011042N3	3	11	[m]	17,7	16,8	15,7	14,6	13,3	11,8	10,2	8,5	6,7	4,9	
KKCW100LB+011042N3	4	11	[m]	20,4	19,1	17,7	16,4	15	13,6	12,1	10,4	8,6	6,8	
KKCW100LA+011042N3	5	11	[m]	23,2	21,5	19,9	18,3	16,7	15,2	13,8	12,2	10,4		
NPSH _R			[m]			2	2	2	2,1	2,3	2,7	3,4		

P₂ = Power rated by the motor

Performance tolerance as per:
UNI/ISO 9906 Grade 3B

For the accessories specification see page "Accessories"

The hatched part of the curve represents the out-of-range of operation.

The impellers will be trimmed to meet the duty point

The performance values refer to units with Caprari motors.

P₂ = Puissance restituée par le moteur

Tolérances sur les performances selon normes:
UNI/ISO 9906 Niveau 3B

Pour les accessoires voir page "Accessories"

La partie en pointillé de la courbe indique l'utilisation hors de la plage.

Le point de fonctionnement désiré peut être obtenu par rognage de roue

Les performances se réfèrent à des groupes avec moteurs Caprari.

P₂ = Potenza resa dal motore

Tolleranze sulle prestazioni secondo norme:
UNI/ISO 9906 Grado 3B

Per accessori vedere pagina accessori

La parte tratteggiata della curva rappresenta il fuori campo di utilizzo.

Le giranti vengono tornite in modo da ottenere il punto di lavoro richiesto

Le prestazioni sono riferite a gruppi con motori Caprari.

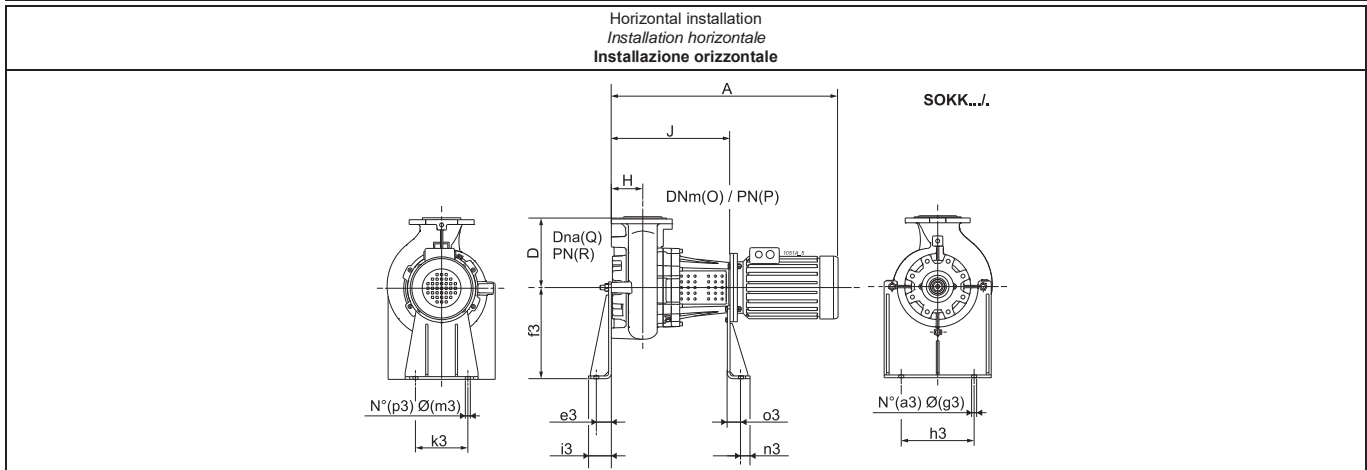
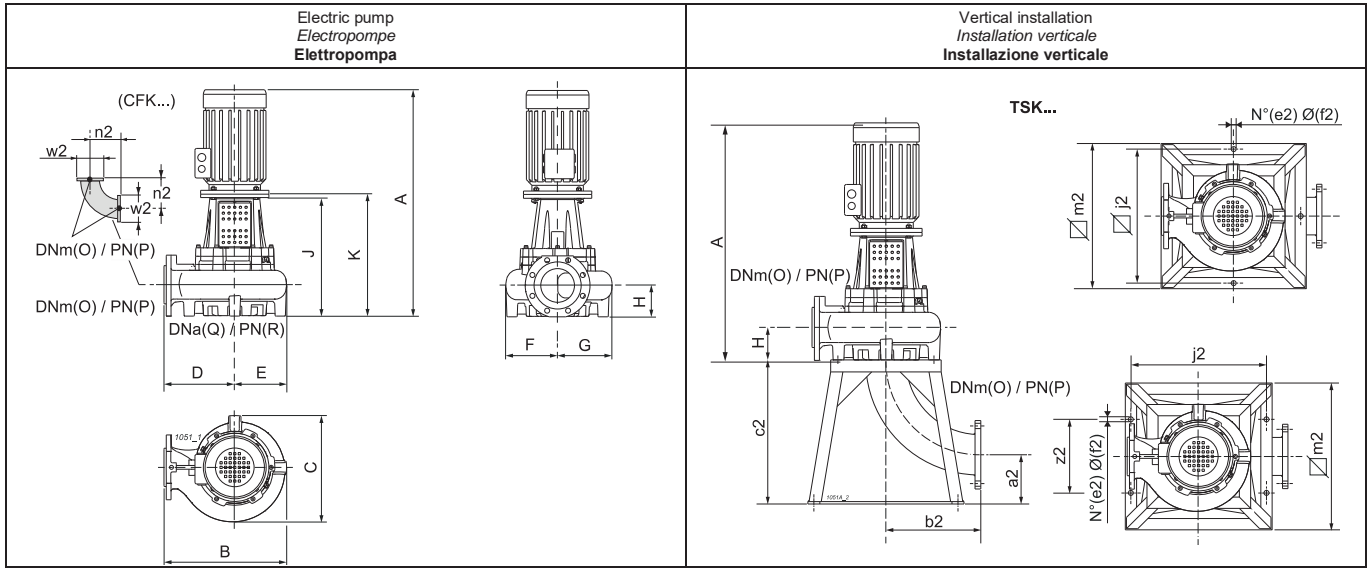

Type Type Tipo	Free passage Passage libre Passaggio Libero	Weight Poids Peso	A	B	C	D	E	F	G	H	J	K	O	P	Q	R	a2	a3	b2
	[mm]		[kg]	[mm]															
KKCW100LG+005542N3	Ø 100	93	903	470	350	295	175	175	175	112	511	528	100	16	100	16	135	2	204
KKCW100LD+007542N3	Ø 100	105	938	470	350	295	175	175	175	112	511	528	100	16	100	16	135	2	204
KKCW100LC+011042N3	Ø 100	159	1128	470	350	295	175	175	175	112	541	558	100	16	100	16	135	2	204
KKCW100LB+011042N3	Ø 100	159	1128	470	350	295	175	175	175	112	541	558	100	16	100	16	135	2	204
KKCW100LA+011042N3	Ø 100	159	1128	470	350	295	175	175	175	112	541	558	100	16	100	16	135	2	204
Type Type Tipo	c2	e2	e3	f2	f3	g3	h3	i3	j2	k3	m2	m3	n2	n3	o3	p3	w2	z2	
	[mm]																		
KKCW100LG+005542N3	340	4	66	22	400	22	320	100	600	230	650	22	204	40	48	2	220	600	
KKCW100LD+007542N3	340	4	66	22	400	22	320	100	600	230	650	22	204	40	48	2	220	600	
KKCW100LC+011042N3	340	4	66	22	400	22	320	100	600	230	650	22	204	40	48	2	220	600	
KKCW100LB+011042N3	340	4	66	22	400	22	320	100	600	230	650	22	204	40	48	2	220	600	
KKCW100LA+011042N3	340	4	66	22	400	22	320	100	600	230	650	22	204	40	48	2	220	600	

For the accessories specification see page "Accessories"

Pour les accessoires voir page "Accessories"

Per accessori vedere pagina accessori

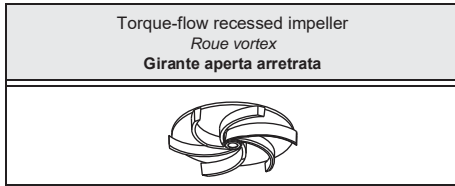

Type Type Tipo	KKCW100L...+...N3	
Conductivity probe Sonde de conductivité Sonda di conduttività	Yes Oui Si	

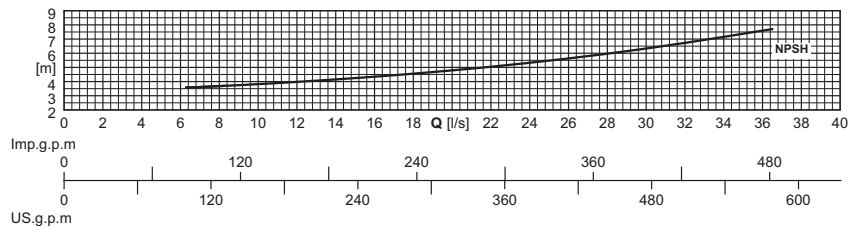
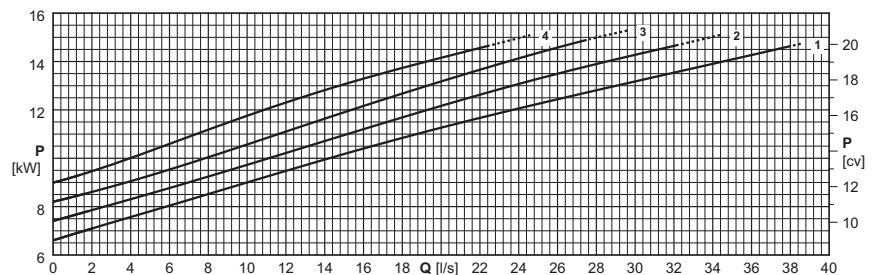
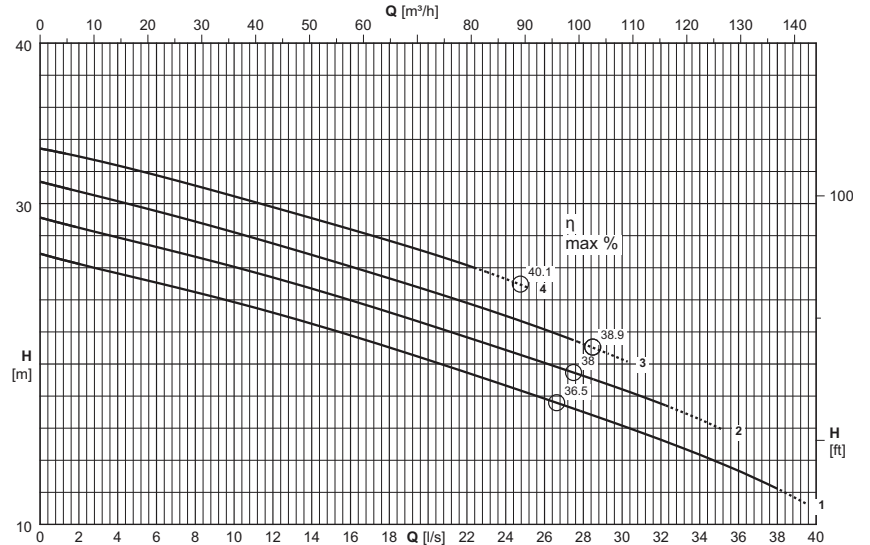

Electric pump type <i>Electropompe type</i> Elettropompa tipo	Curve <i>Courbe</i> Curva	Motor power <i>Puiss. moteur</i> Potenza motore	Capacity <i>Debit</i> Portata														
			[l/s]	0	4	8	12	16	20	24	28	32	36	40			
		P ₂	[m³/h]	0	14,4	29	43	58	72	86	101	115	130	144			
	(N°)	[kW]	Head <i>Hauteur</i> Prevalenza														
KKCW100LZ+015022N3	1	15	[m]	26,9	25,7	24,5	23,2	21,8	20,3	18,7	17	15,3	13,3				
KKCW100LW+015022N3	2	15	[m]	29,1	27,9	26,7	25,4	24	22,5	20,9	19,3	17,5					
KKCW100LT+015022N3	3	15	[m]	31,4	30,1	28,9	27,5	26,1	24,6	23	21,2						
KKCW100LR+015022N3	4	15	[m]	33,4	32,4	31,1	29,8	28,4	26,9	25,3							
NPSH _R			[m]			3,7	4	4,3	4,8	5,3	6	6,7	7,6				

P₂ = Power rated by the motor

Performance tolerance as per:
UNI/ISO 9906 Grade 3B

For the accessories specification see page "Accessories"

The hatched part of the curve represents the out-of-range of operation.

The impellers will be trimmed to meet the duty point

The performance values refer to units with Caprari motors.

P₂ = Puissance restituée par le moteur

Tolérances sur les performances selon normes:
UNI/ISO 9906 Niveau 3B

Pour les accessoires voir page "Accessories"

La partie pointillée de la courbe indique l'utilisation hors de la plage.

Le point de fonctionnement désiré peut être obtenu par rognage de roue

Les performances se réfèrent à des groupes avec moteurs Caprari.

P₂ = Potenza resa dal motore

Tolleranze sulle prestazioni secondo norme:
UNI/ISO 9906 Grado 3B

Per accessori vedere pagina accessori

La parte tratteggiata della curva rappresenta il fuori campo di utilizzo.

Le giranti vengono tornite in modo da ottenere il punto di lavoro richiesto

Le prestazioni sono riferite a gruppi con motori Caprari.

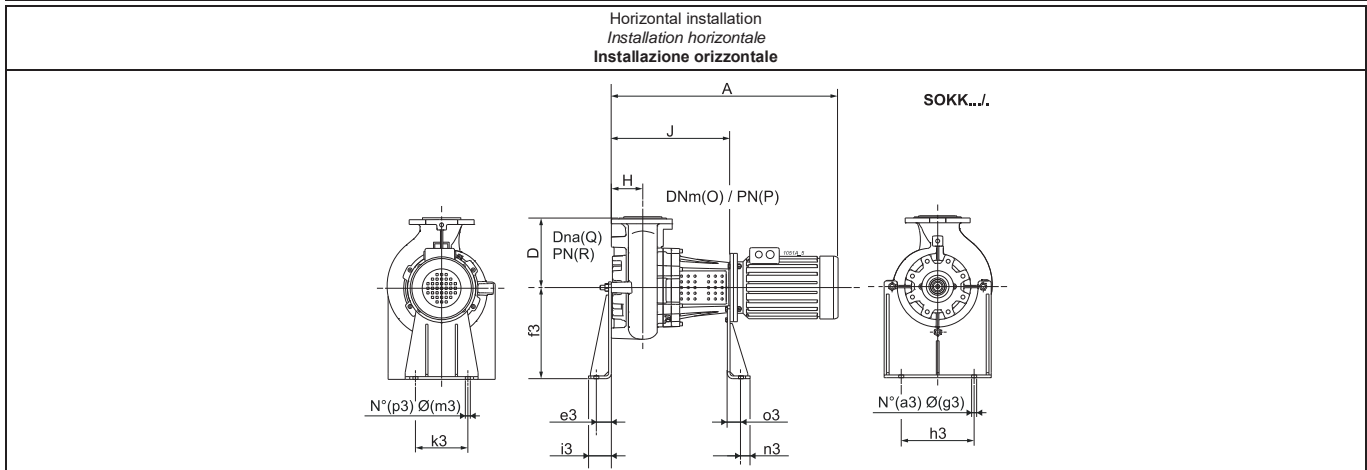
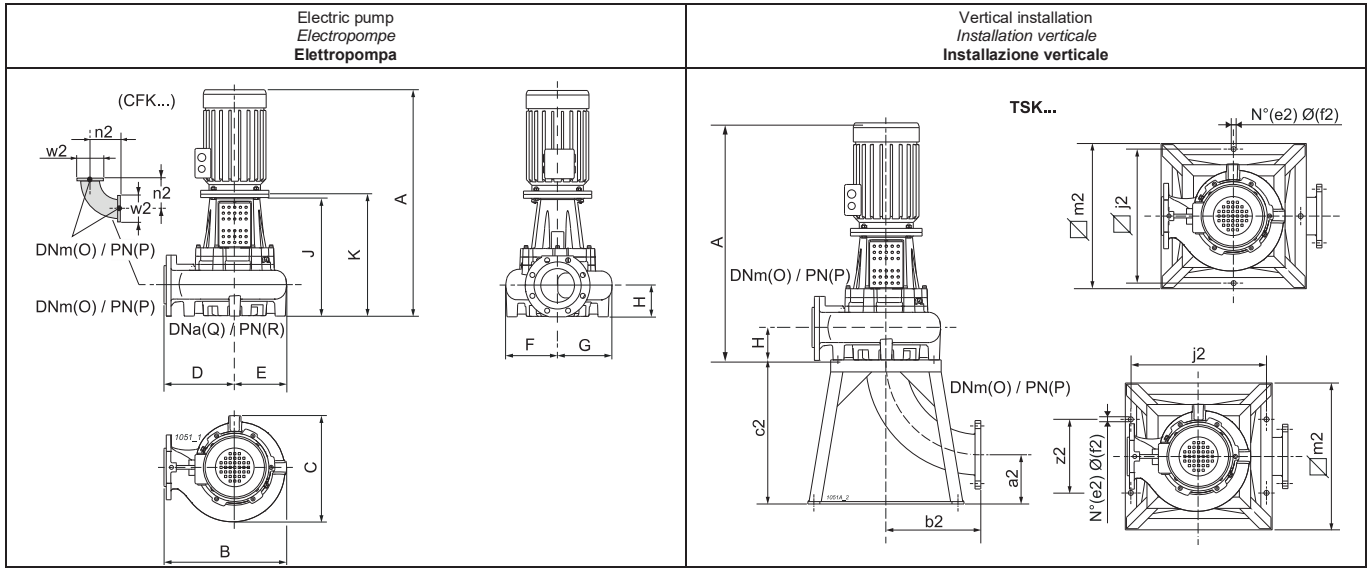

Type Type Tipo	Free passage Passage libre Passaggio Libero	Weight Poids Peso	A	B	C	D	E	F	G	H	J	K	O	P	Q	R	a2	a3	b2
	[mm]	[kg]	[mm]																
KKCW100LZ+015022N3	Ø 100	147	1128	470	350	295	175	175	175	112	541	558	100	16	100	16	135	2	204
KKCW100LW+015022N3	Ø 100	148	1128	470	350	295	175	175	175	112	541	558	100	16	100	16	135	2	204
KKCW100LT+015022N3	Ø 100	148	1128	470	350	295	175	175	175	112	541	558	100	16	100	16	135	2	204
KKCW100LR+015022N3	Ø 100	149	1128	470	350	295	175	175	175	112	541	558	100	16	100	16	135	2	204
Type Type Tipo	c2	e2	e3	f2	f3	g3	h3	i3	j2	k3	m2	m3	n2	n3	o3	p3	w2	z2	
	[mm]																		
KKCW100LZ+015022N3	340	4	66	22	400	22	320	100	600	230	650	22	204	40	48	2	220	600	
KKCW100LW+015022N3	340	4	66	22	400	22	320	100	600	230	650	22	204	40	48	2	220	600	
KKCW100LT+015022N3	340	4	66	22	400	22	320	100	600	230	650	22	204	40	48	2	220	600	
KKCW100LR+015022N3	340	4	66	22	400	22	320	100	600	230	650	22	204	40	48	2	220	600	

For the accessories specification see page "Accessories"

Pour les accessoires voir page "Accessories"

Per accessori vedere pagina accessori

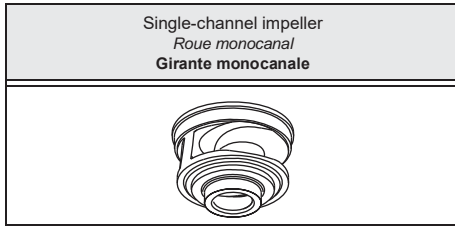

Type Type Tipo	KKCM150L+...N3	
Conductivity probe Sonde de conductivité Sonda di conduttività	Yes Oui Sì	

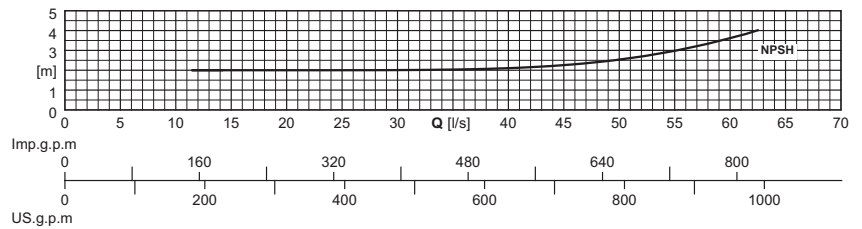
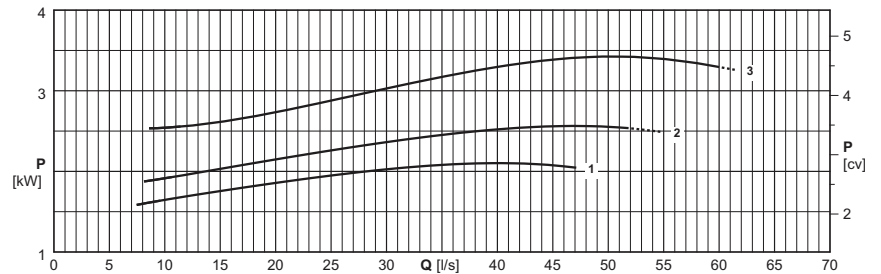
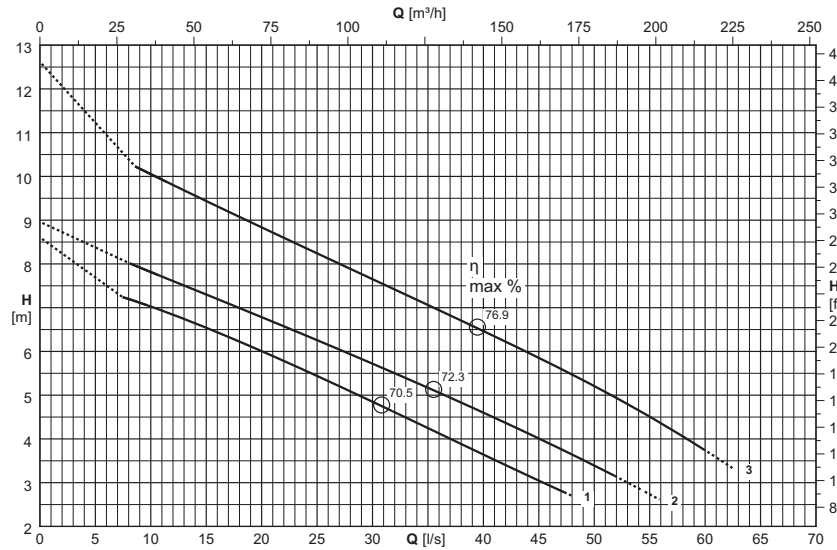

Electric pump type <i>Electropompe type</i> Elettropompa tipo	Curve <i>Courbe</i> Curva	Motor power <i>Puiss. moteur</i> Potenza motore	Capacity <i>Debit</i> Portata												
			[l/s]	0	12	18	24	30	36	42	48	54	60	66	
	(N°)	[kW]	[m³/h]	0	43	65	86	108	130	151	173	194	216	238	
			Head <i>Hauteur</i> Prevalenza												
KKCM150LG+003061N3	1	3	[m]	8,6	6,8	6,2	5,6	4,8	4,1	3,4	2,7				
KKCM150LD+003061N3	2	3	[m]	9	7,6	7	6,4	5,7	5,1	4,4	3,6	2,9			
KKCM150LA+004061N3	3	4	[m]	12,6	9,8	9,1	8,4	7,7	6,9	6,2	5,5	4,7	3,7		
NPSH _R			[m]		2	2	2	2	2,1	2,2	3,3	2,7	3,6		

P_2 = Power rated by the motor
Performance tolerance as per:
UNI/ISO 9906 Grade 3B
For the accessories specification see page "Accessories"
The hatched part of the curve represents the out-of-range of operation.
The performance values refer to units with Caprari motors.

P_2 = Puissance restituée par le moteur
Tolérances sur les performances selon normes:
UNI/ISO 9906 Niveau 3B
Pour les accessoires voir page "Accessories"
La partie en pointillé de la courbe indique l'utilisation hors de la plage.
Les performances se réfèrent à des groupes avec moteurs Caprari.

P_2 = Potenza resa dal motore
Tolleranze sulle prestazioni secondo norme:
UNI/ISO 9906 Grado 3B
Per accessori vedere pagina accessori
La parte tratteggiata della curva rappresenta il fuori campo di utilizzo.
Le prestazioni sono riferite a gruppi con motori Caprari.

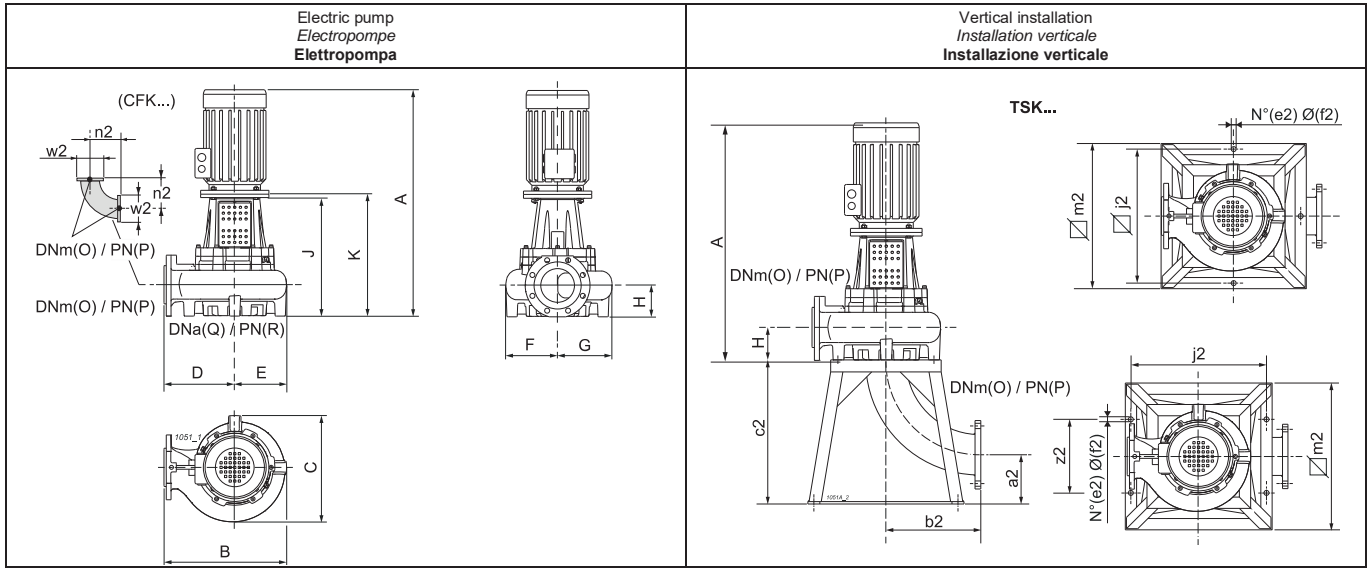

Horizontal installation
Installation horizontale
Installazione orizzontale

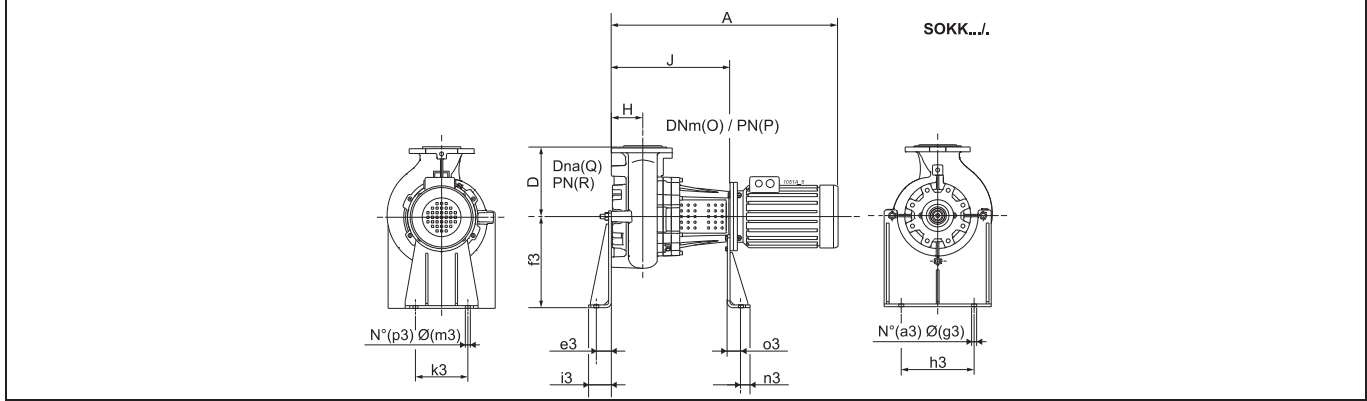

Type Type Tipo	Free passage Passage libre Passaggio Libero	Weight Poids Peso	A	B	C	D	E	F	G	H	J	K	O	P	Q	R	a2	a3	b2
	[mm]	[kg]	[mm]																
KKCM150LG+003061N3	Ø 100	152	913	532	467	305	227	227	240	138	521	538	150	16	150	16	205	2	395
KKCM150LD+003061N3	Ø 100	152	913	532	467	305	227	227	240	138	521	538	150	16	150	16	205	2	395
KKCM150LA+004061N3	Ø 100	159	948	532	467	305	227	227	240	138	521	538	150	16	150	16	205	2	395
Type Type Tipo	c2	e2	e3	f2	f3	g3	h3	i3	j2	k3	m2	m3	n2	n3	o3	p3	w2	z2	
	[mm]																		
KKCM150LG+003061N3	600	4	66	22	400	22	320	100	600	230	650	22	395	40	48	2	285	600	
KKCM150LD+003061N3	600	4	66	22	400	22	320	100	600	230	650	22	395	40	48	2	285	600	
KKCM150LA+004061N3	600	4	66	22	400	22	320	100	600	230	650	22	395	40	48	2	285	600	

For the accessories specification see page "Accessories"

Pour les accessoires voir page "Accessories"

Per accessori vedere pagina accessori

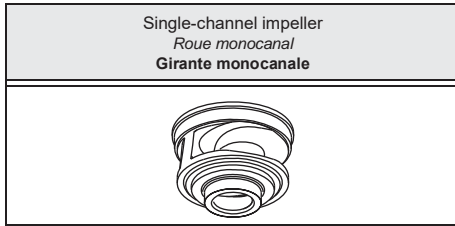

Type Type Tipo	KKCM150H.+...N3	
Conductivity probe Sonde de conductivité Sonda di conduttività	Yes Oui Sì	

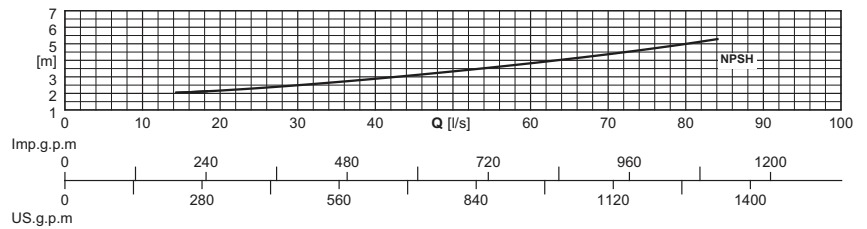
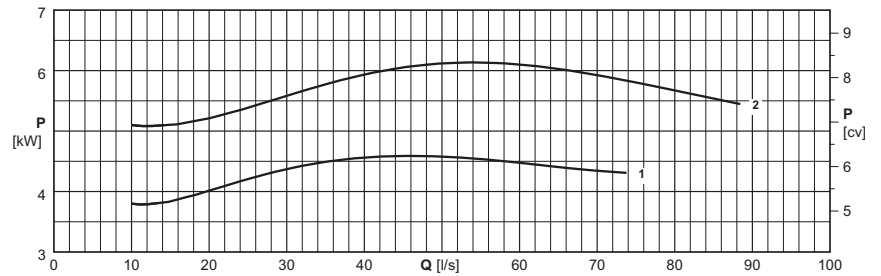
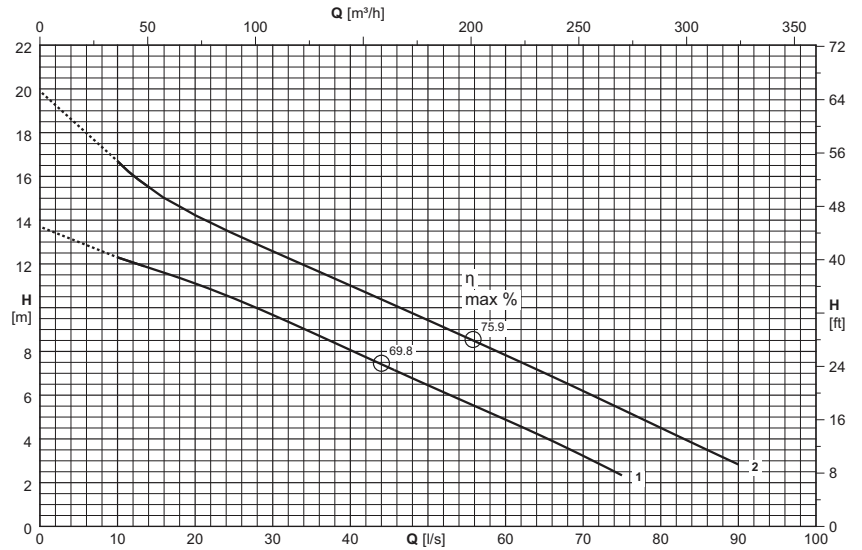

Electric pump type <i>Electropompe type</i> Elettropompa tipo	Curve <i>Courbe</i> Curva	Motor power <i>Puiss. moteur</i> Potenza motore	Capacity <i>Debit</i> Portata														
			[l/s]	0	18	27	36	45	54	63	72	81	90	99			
		P_2	[m³/h]	0	65	97	130	162	194	227	259	292	324	356			
	(N°)	[kW]	Head <i>Hauteur</i> Prevalenza														
KKCM150HD+005542N3	1	5,5	[m]	13,7	11,4	10,1	8,7	7,3	5,8	4,4	2,9						
KKCM150HA+007542N3	2	7,5	[m]	19,9	14,6	13,1	11,6	10,2	8,8	7,3	5,9	4,3	2,8				
NPSH _R			[m]		2,3	2,4	2,7	3,1	3,5	4	4,8	5					

P_2 = Power rated by the motor

Performance tolerance as per:
UNI/ISO 9906 Grade 3B

For the accessories specification see page "Accessories"

The hatched part of the curve represents the out-of-range of operation.

The performance values refer to units with Caprari motors.

P_2 = Puissance restituée par le moteur

Tolérances sur les performances selon normes:
UNI/ISO 9906 Niveau 3B

Pour les accessoires voir page "Accessories"

La partie en pointillé de la courbe indique l'utilisation hors de la plage.

Les performances se réfèrent à des groupes avec moteurs Caprari.

P_2 = Potenza resa dal motore

Tolleranze sulle prestazioni secondo norme:
UNI/ISO 9906 Grado 3B

Per accessori vedere pagina accessori

La parte tratteggiata della curva rappresenta il fuori campo di utilizzo.

Le prestazioni sono riferite a gruppi con motori Caprari.

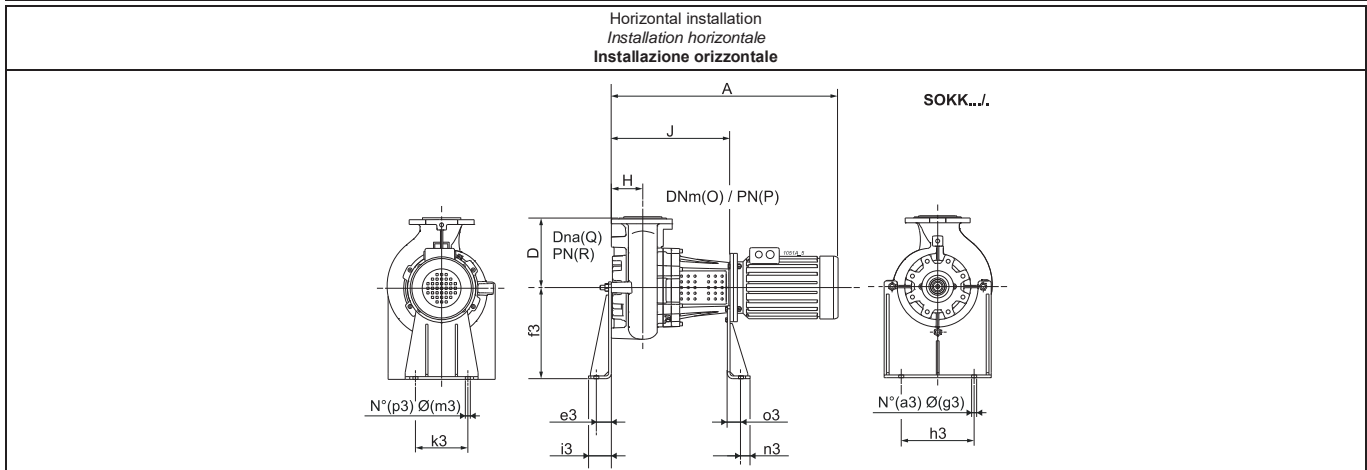
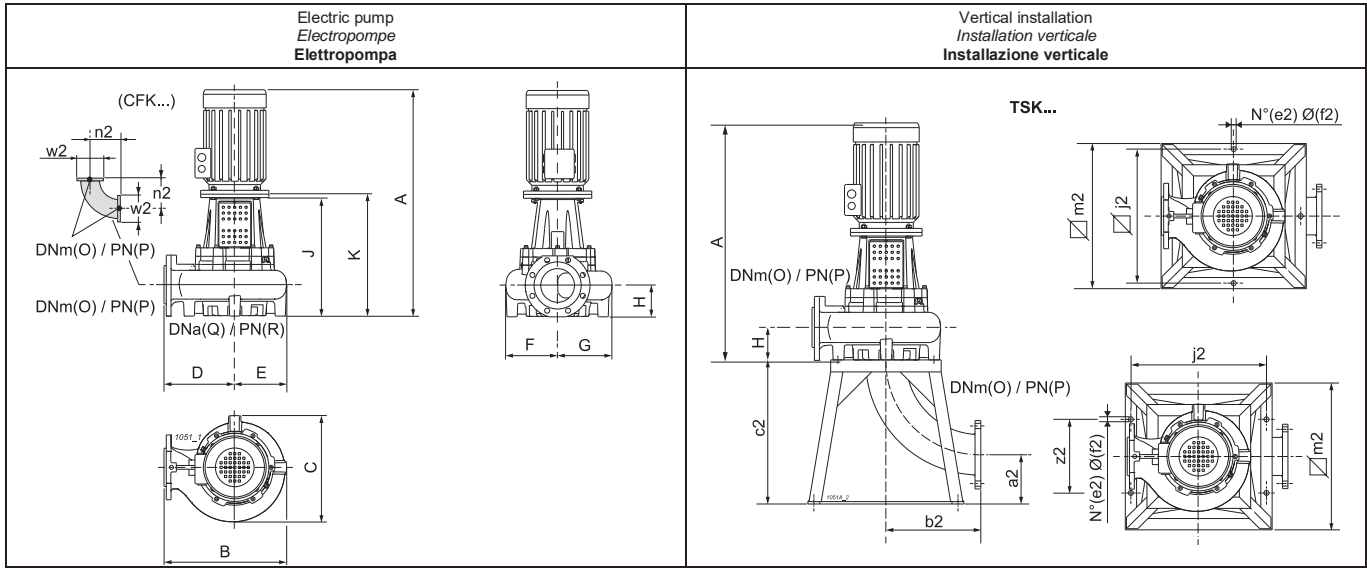

Type Type Tipo	Free passage Passage libre Passaggio Libero	Weight Poids Peso	A	B	C	D	E	F	G	H	J	K	O	P	Q	R	a2	a3	b2
	[mm]	[kg]	[mm]																
KKCM150HD+005542N3	Ø 80	151	857,5	567	465,5	340	227	227	238,5	138	465,5	482,5	150	16	150	16	205	2	395
KKCM150HA+007542N3	Ø 80	159	892,5	567	465,5	340	227	227	238,5	138	465,5	482,5	150	16	150	16	205	2	395
Type Type Tipo	c2	e2	e3	f2	f3	g3	h3	i3	j2	k3	m2	m3	n2	n3	o3	p3	w2	z2	
	[mm]																		
KKCM150HD+005542N3	600	4	66	22	400	22	320	100	600	230	650	22	395	40	48	2	285	600	
KKCM150HA+007542N3	600	4	66	22	400	22	320	100	600	230	650	22	395	40	48	2	285	600	

For the accessories specification see page "Accessories"

Pour les accessoires voir page "Accessories"

Per accessori vedere pagina accessori

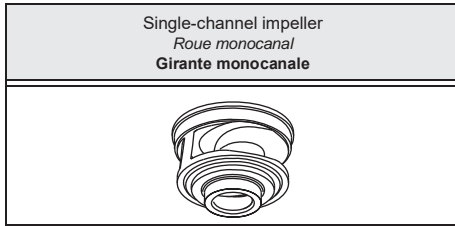

Type Type Tipo	KKCM150L...+...N3	
Conductivity probe Sonde de conductivité Sonda di conduttività	Yes Oui Sì	

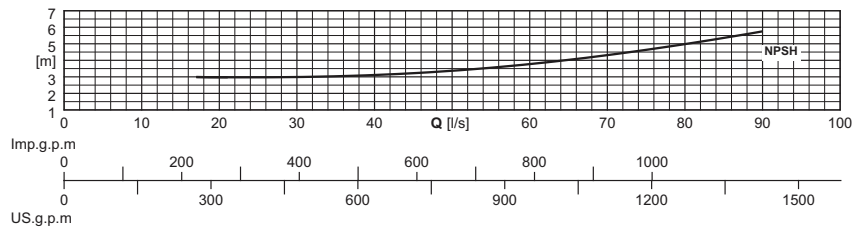
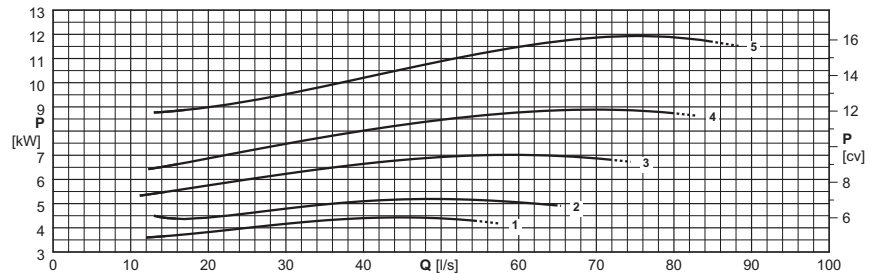
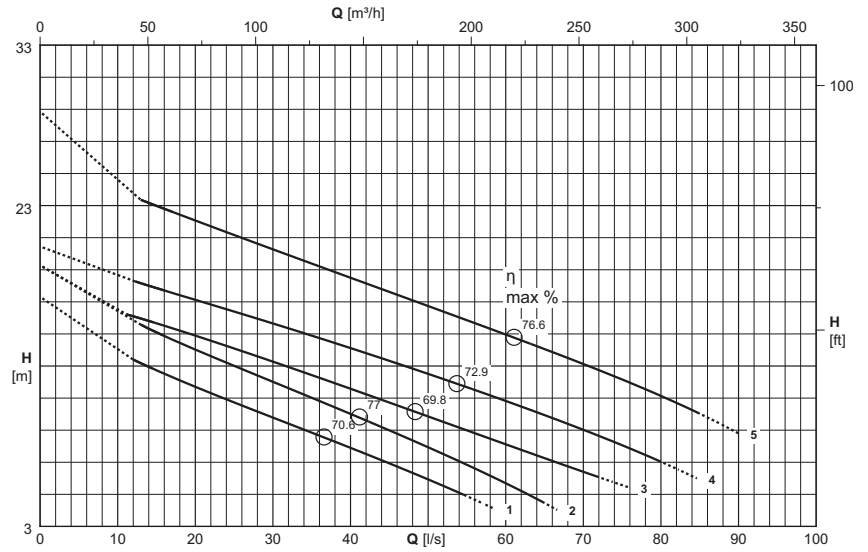

Electric pump type <i>Electropompe type</i> Elettropompa tipo	Curve <i>Courbe</i> Curva	Motor power <i>Puiss. moteur</i> Potenza motore	Capacity <i>Debit</i> Portata													
			[l/s]	0	18	27	36	45	54	63	72	81	90			
		P ₂	[m³/h]	0	65	97	130	162	194	227	259	292	324			
	(N°)	[kW]	Head <i>Hauteur</i> Prevalenza													
KKCM150LM+005542N3	1	5,5	[m]	17,3	12,1	10,4	8,7	6,9	5,1							
KKCM150LI+005542N3	2	5,5	[m]	19,3	14,4	12,6	10,8	9	7,1	5						
KKCM150LG+007542N3	3	7,5	[m]	19,3	15,2	13,8	12,3	10,7	9,2	7,6	6,1					
KKCM150LD+011042N3	4	11	[m]	20,4	17,4	16,1	14,7	13,3	11,8	10,3	8,6	6,8				
KKCM150LA+015042N3	5	15	[m]	28,9	22,4	20,8	19,2	17,6	16	14,4	12,7	10,9	8,8			
NPSH _R			[m]		3	3	3,1	3,4	3,5	3,9	4,3	4,9				

P₂ = Power rated by the motor

Performance tolerance as per:
UNI/ISO 9906 Grade 3B

For the accessories specification see page "Accessories"

The hatched part of the curve represents the out-of-range of operation.

The performance values refer to units with Caprari motors.

P₂ = Puissance restituée par le moteur

Tolérances sur les performances selon normes:
UNI/ISO 9906 Niveau 3B

Pour les accessoires voir page "Accessories"

La partie pointillée de la courbe indique l'utilisation hors de la plage.

Les performances se réfèrent à des groupes avec moteurs Caprari.

P₂ = Potenza resa dal motore

Tolleranze sulle prestazioni secondo norme:
UNI/ISO 9906 Grado 3B

Per accessori vedere pagina accessori

La parte tratteggiata della curva rappresenta il fuori campo di utilizzo.

Le prestazioni sono riferite a gruppi con motori Caprari.

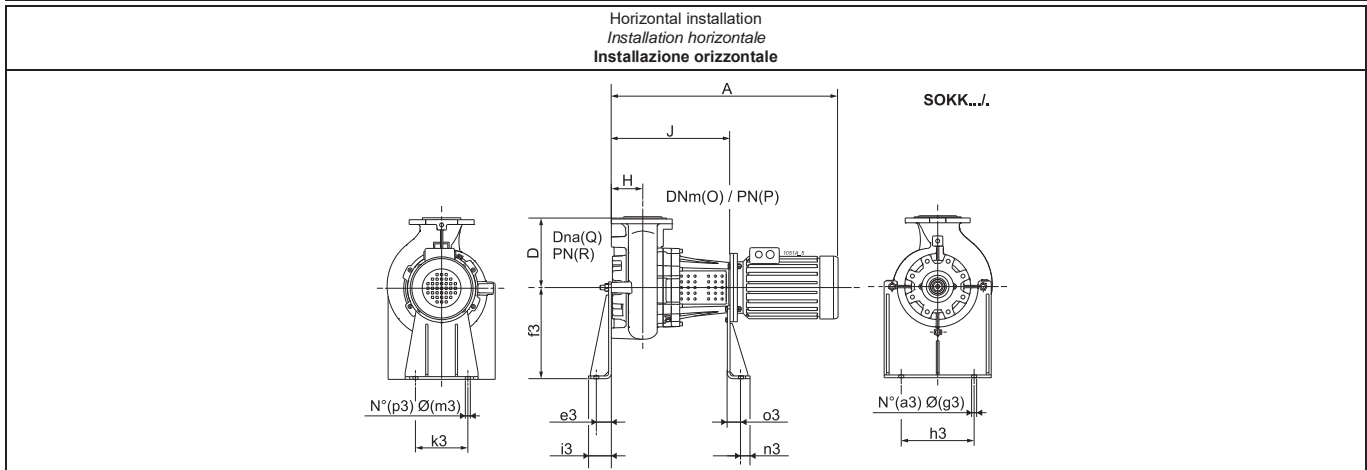
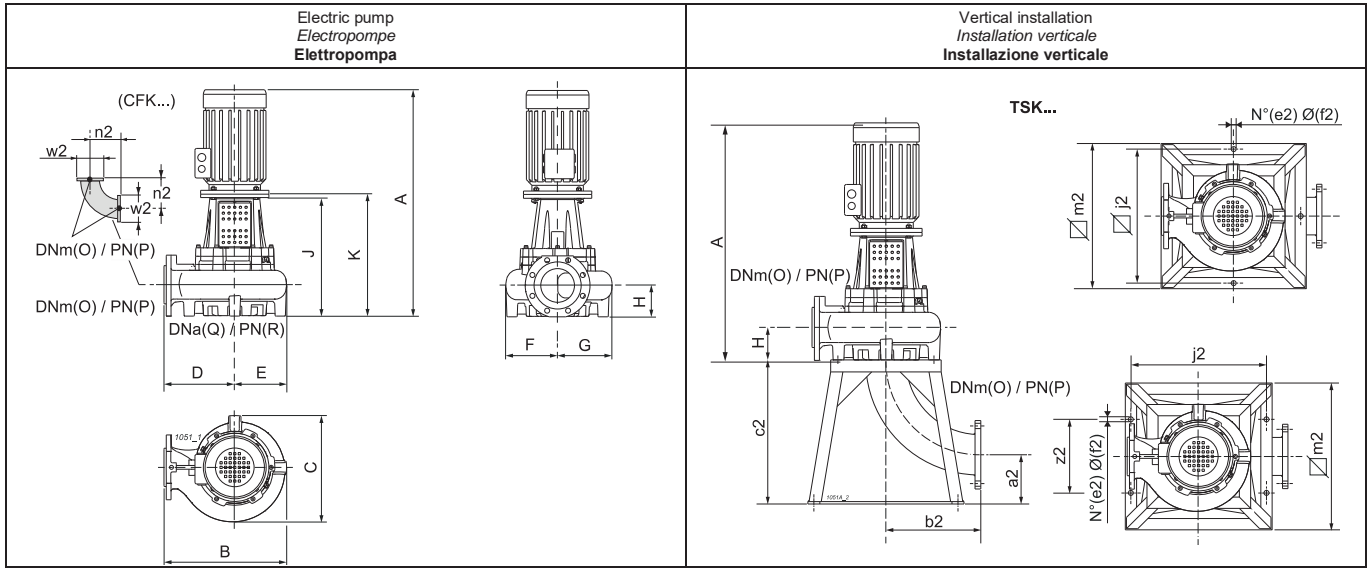

Type Type Tipo	Free passage Passage libre Passaggio Libero	Weight Poids Peso	A	B	C	D	E	F	G	H	J	K	O	P	Q	R	a2	a3	b2
	[mm]		[kg]	[mm]															
KKCM150LM+005542N3	Ø 80	152	913	532	467	305	227	227	240	138	521	538	150	16	150	16	205	2	395
KKCM150LI+005542N3	Ø 80	152	913	532	467	305	227	227	240	138	521	538	150	16	150	16	205	2	395
KKCM150LG+007542N3	Ø 100	167	948	532	467	305	227	227	240	138	521	538	150	16	150	16	205	2	395
KKCM150LD+011042N3	Ø 100	189	1138	532	467	305	227	227	240	138	551	568	150	16	150	16	205	2	395
KKCM150LA+015042N3	Ø 100	210	1138	532	467	305	227	227	240	138	551	568	150	16	150	16	205	2	395
Type Type Tipo	c2	e2	e3	f2	f3	g3	h3	i3	j2	k3	m2	m3	n2	n3	o3	p3	w2	z2	
	[mm]																		
KKCM150LM+005542N3	600	4	66	22	400	22	320	100	600	230	650	22	395	40	48	2	285	600	
KKCM150LI+005542N3	600	4	66	22	400	22	320	100	600	230	650	22	395	40	48	2	285	600	
KKCM150LG+007542N3	600	4	66	22	400	22	320	100	600	230	650	22	395	40	48	2	285	600	
KKCM150LD+011042N3	600	4	66	22	400	22	320	100	600	230	650	22	395	40	48	2	285	600	
KKCM150LA+015042N3	600	4	66	22	400	22	320	100	600	230	650	22	395	40	48	2	285	600	

For the accessories specification see page "Accessories"

Pour les accessoires voir page "Accessories"

Per accessori vedere pagina accessori

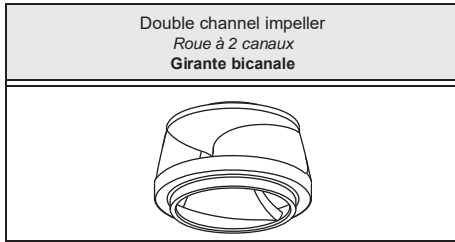

Type Type Tipo	KKCD200N...+...N3	
Conductivity probe Sonde de conductivité Sonda di conduttività	Yes Oui Sì	

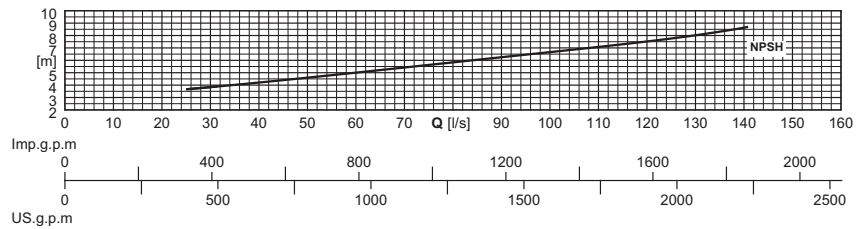
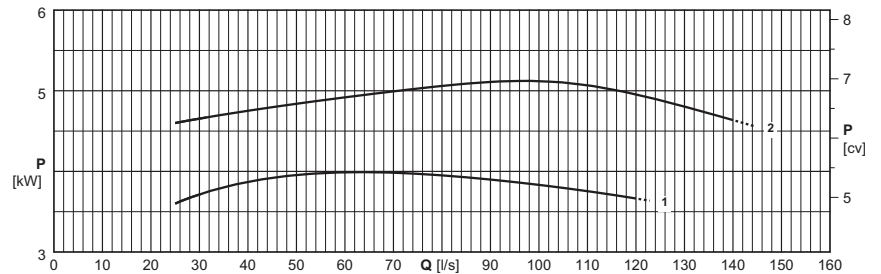
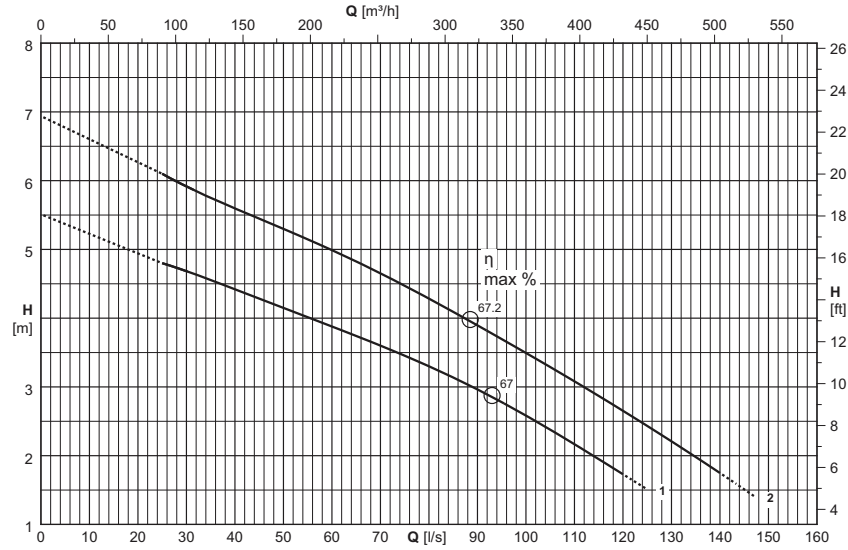

Electric pump type Electropompe type Elettropompa tipo	Curve Courbe Curva	Motor power Puiss. moteur Potenza motore	Capacity Débit Portata													
			[l/s]	0	30	45	60	75	90	105	120	135	150			
		P ₂	[m³/h]	0	108	162	216	270	324	378	432	486	540			
	(N°)	[kW]	Head Hauteur Prevalenza													
KKCD200NP+004061N3	1	4	[m]	5,5	4,7	4,3	3,9	3,5	3	2,4	1,7					
KKCD200NG+005562N3	2	5,5	[m]	6,9	5,9	5,4	5	4,5	3,9	3,3	2,7	2				
NPSH _R			[m]		3,8	4,4	5	5,7	6,2	6,9	8,1	8,3				

P₂ = Power rated by the motor

Performance tolerance as per:
UNI/ISO 9906 Grade 3B

For the accessories specification see page "Accessories"

The hatched part of the curve represents the out-of-range of operation.

The performance values refer to units with Caprari motors.

P₂ = Puissance restituée par le moteur

Tolérances sur les performances selon normes:
UNI/ISO 9906 Niveau 3B

Pour les accessoires voir page "Accessories"

La partie pointillée de la courbe indique l'utilisation hors de la plage.

Les performances se réfèrent à des groupes avec moteurs Caprari.

P₂ = Potenza resa dal motore

Tolleranze sulle prestazioni secondo norme:
UNI/ISO 9906 Grado 3B

Per accessori vedere pagina accessori

La parte tratteggiata della curva rappresenta il fuori campo di utilizzo.

Le prestazioni sono riferite a gruppi con motori Caprari.

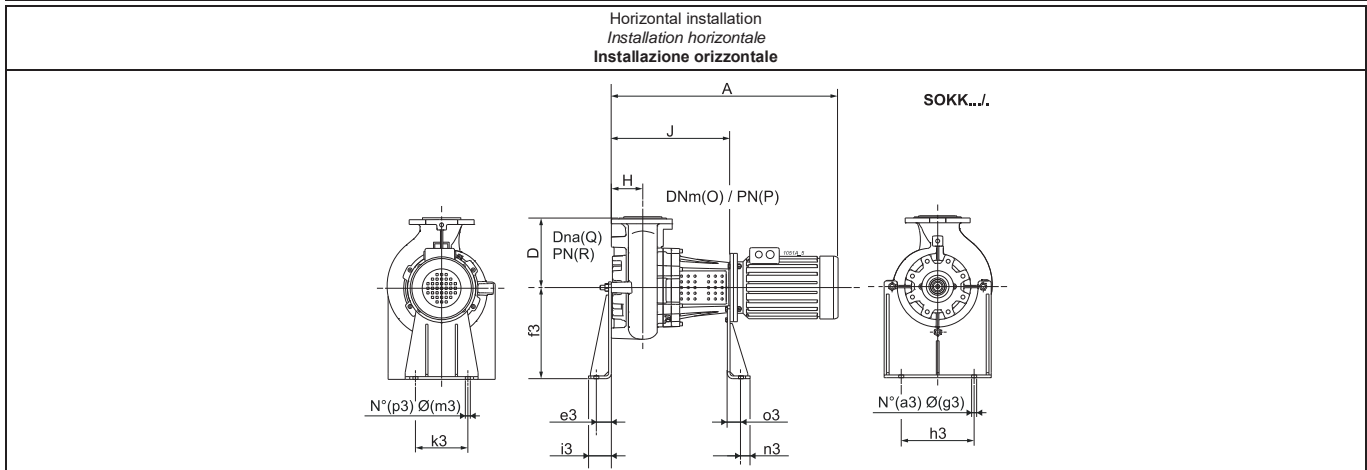
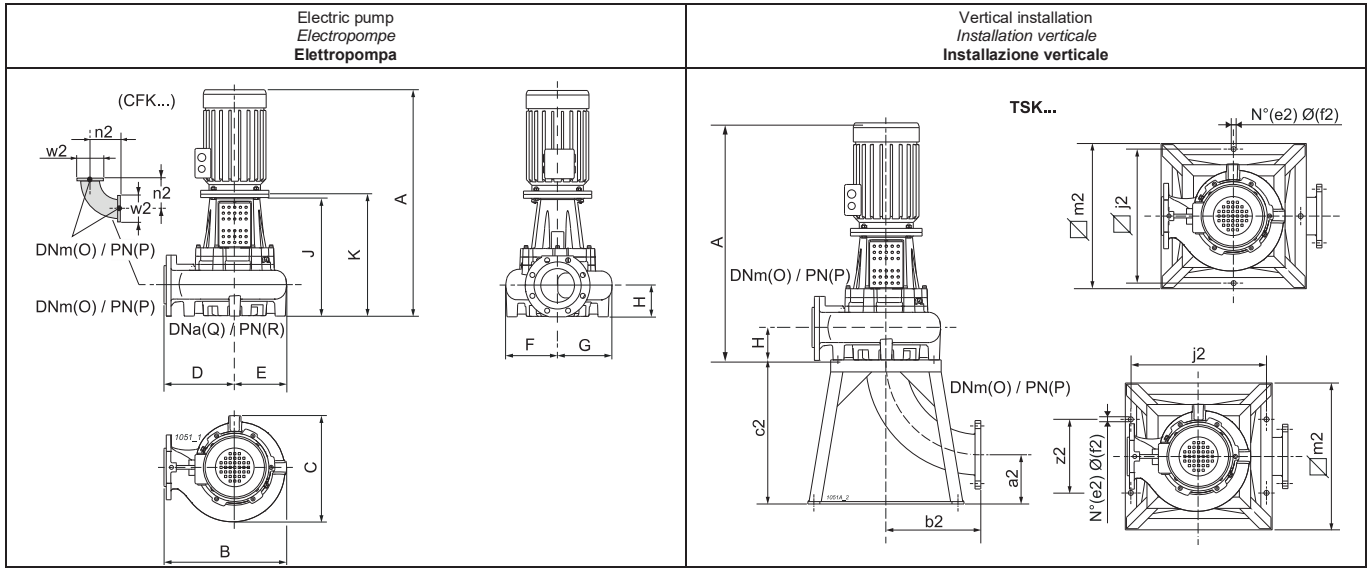

Type Type Tipo	Free passage Passage libre Passaggio Libero	Weight Poids Peso	A	B	C	D	E	F	G	H	J	K	O	P	Q	R	a2	a3	b2
			[mm]	[kg]	[mm]														
KKCD200NP+004061N3	Ø 100	244	984,5	840	580	550	290	240	340	170	557,5	574,5	200	10	200	10	300	2	310
KKCD200NG+005562N3	Ø 100	291	984,5	840	580	550	290	240	340	170	557,5	574,5	200	10	200	10	300	2	310
Type Type Tipo	c2	e2	e3	f2	f3	g3	h3	i3	j2	k3	m2	m3	n2	n3	o3	p3	w2	z2	
	[mm]																		
KKCD200NP+004061N3	600	4	66	22	400	22	320	100	600	230	650	22	310	40	48	2	340	600	
KKCD200NG+005562N3	600	4	66	22	400	22	320	100	600	230	650	22	310	40	48	2	340	600	

For the accessories specification see page "Accessories"

Pour les accessoires voir page "Accessories"

Per accessori vedere pagina accessori

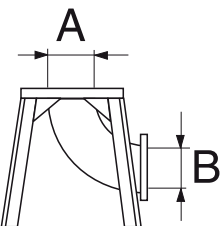
Base frame (dipped galvanized steel) Chassis de soutien (acier galvanisé) Telaio di sostegno (acciaio zincato a caldo)	Type Type Tipo	A		B		Weight Poids Peso [Kg]	Electric pump type Electropompe type Elettropompa tipo						
		DN	UNI PN	DN	UNI PN		KKCW080L	KKCM080L	KKCW100L	KKCM150H	KKCM150L	KKCD200N	
	TSK100A	100	16	100	16	34	-	-	I	-	-	-	
	TSKIA	150	16	150	16	50	-	-	-	I	I	-	
	TSKK80A	80	16	80	16	35	I	I	-	-	-	-	
	TSKMA	200	10	200	10	70	-	-	-	-	-	I	

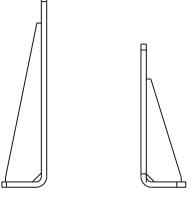
Supports (Steel with protective paint) Support de soutien (Acier revêtu de peinture de protection) Supporti (acciaio con vernice protettiva)	Type Type Tipo	Weight Poids Peso [Kg]	Electric pump type Electropompe type Elettropompa tipo							
			KKCW080L	KKCM080L	KKCW100L	KKCM150H	KKCM150L	KKCD200N		
	SOKK80/3	33	-	5,5-7,5	-	-	-	-	-	
	SOKK80/3/160	33	11-15	11	-	-	-	-	-	
	SOKK100/3	34	-	-	3-4-5,5-7,5	-	-	-	-	
	SOKK100/4	34,5	-	-	11-15	-	-	-	-	
	SOKK150/3	33	-	-	-	5,5-7,5	-	-	-	
	SOKK200/3	32	-	-	-	-	-	3-4-5,5-7,5	4-5,5	
	SOKK200/4	33,5	-	-	-	-	-	11-15	7,5-11-15-22	

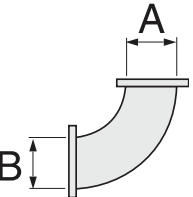
Flanged elbow (dipped galvanized steel) Coude bridé (acier galvanisé à chaud) Curva flangiata (acciaio zincato a caldo)	Type Type Tipo	A		B		Weight Poids Peso [Kg]	Electric pump type Electropompe type Elettropompa tipo					
		DN	UNI PN	DN	UNI PN		KKCW080L	KKCM080L	KKCW100L	KKCM150H	KKCM150L	KKCD200N
	CFK80	80	16	80	16	10,5	I	I	-	-	-	-
	CFK100	100	16	100	16	12	-	-	I	-	-	-
	CFK150	150	16	150	16	25,5	-	-	-	I	I	-
	CFK200	200	10	200	10	31	-	-	-	-	-	I

Performance ranges
Champs de performance
Campo di prestazione

KKCW100N
KKCM100N
KKCM150N
KKCM200P
KKCD200N
KKCD250P

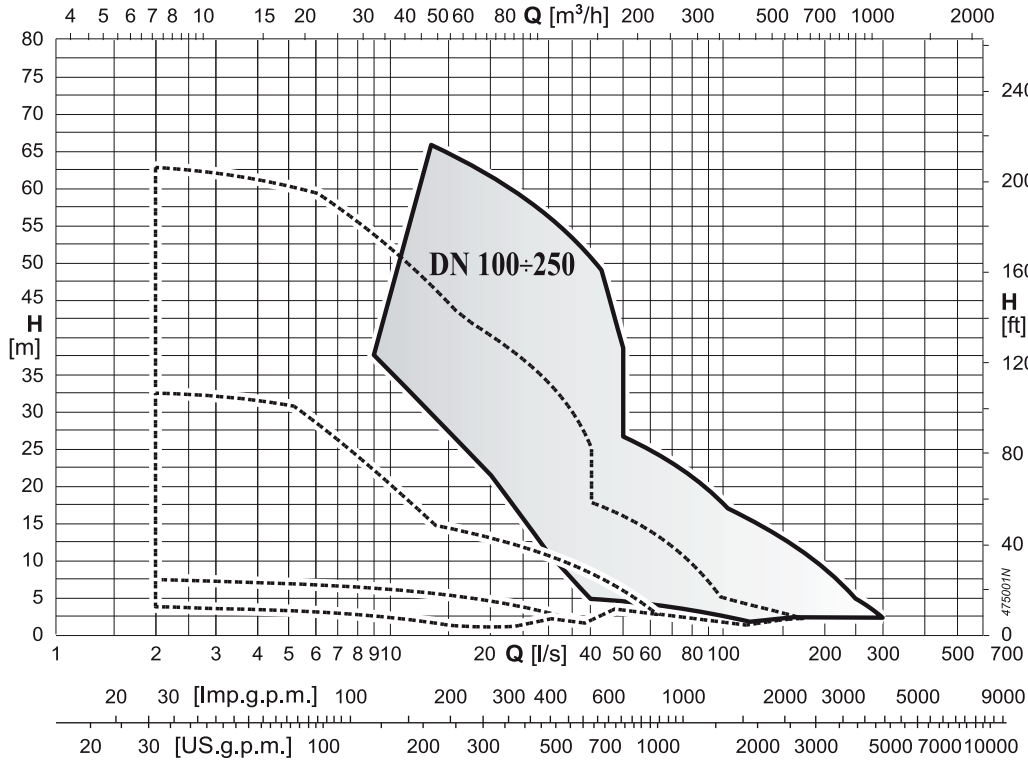

K-Kompact DN 100÷250

caprari

Electric pump coding
Exemplification du sigle de l'électropompe
Esemplificazione sigla elettropompa

KKCW100N
KKCM100N
KKCM150N
KKCM200P
KKCD200N
KKCD250P

Motor code match
Codes communs avec le sigle moteur
Comunanze con sigla motore

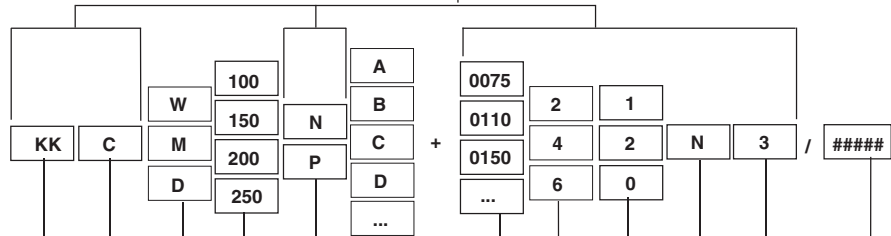

Series - Série - Serie _____

50 Hz _____

Impeller: vortex "W"; single-channel "M"; double channel "D"
Roue: vortex "W"; monocanal "M"; à 2 canaux "D"
Girante: a vortice "W"; monocanale "M"; bicanale "D" _____

Size of pump end (DNm)
Grandeur partie hydraulique (DNm)
Grandezza parte idraulica (DNm) _____

Size of electric motor flanging
Dimension bride moteur électrique
Grandezza flangiatura motore elettrico _____

Impeller diameter - Réduction roue - Riduzione girante _____

Motor output power code
Code puissance rendement moteur
Codice potenza resa motore _____

Number of poles - Nombre de pôles - Numero poli _____

Constructional features of electric motor threephase, class F insulation, IP55-IEC protection degree
Caractéristiques de fabrication moteur électrique triphasé, classe d'isolation F, degré de protection IP55-IEC
Caratteristiche costruttive motore elettrico trifase, classe di isolamento F, grado di protezione IP55-IEC
1 = 230 (220-240) V- Δ / 400 (380-415) V-Y
2 = 400 (380-415) V- Δ / 700 (660-720) V-Y 0 = Specials - Spéciaux - Speciali

Standard electric pump: (N) ;
Electropompe standard: (N) ;
Elettropompa standard: (N) ; _____

Generational code - Code générationnel - Codice generazionale _____

Various specialities - Spécialités diverses - Specialità varie _____

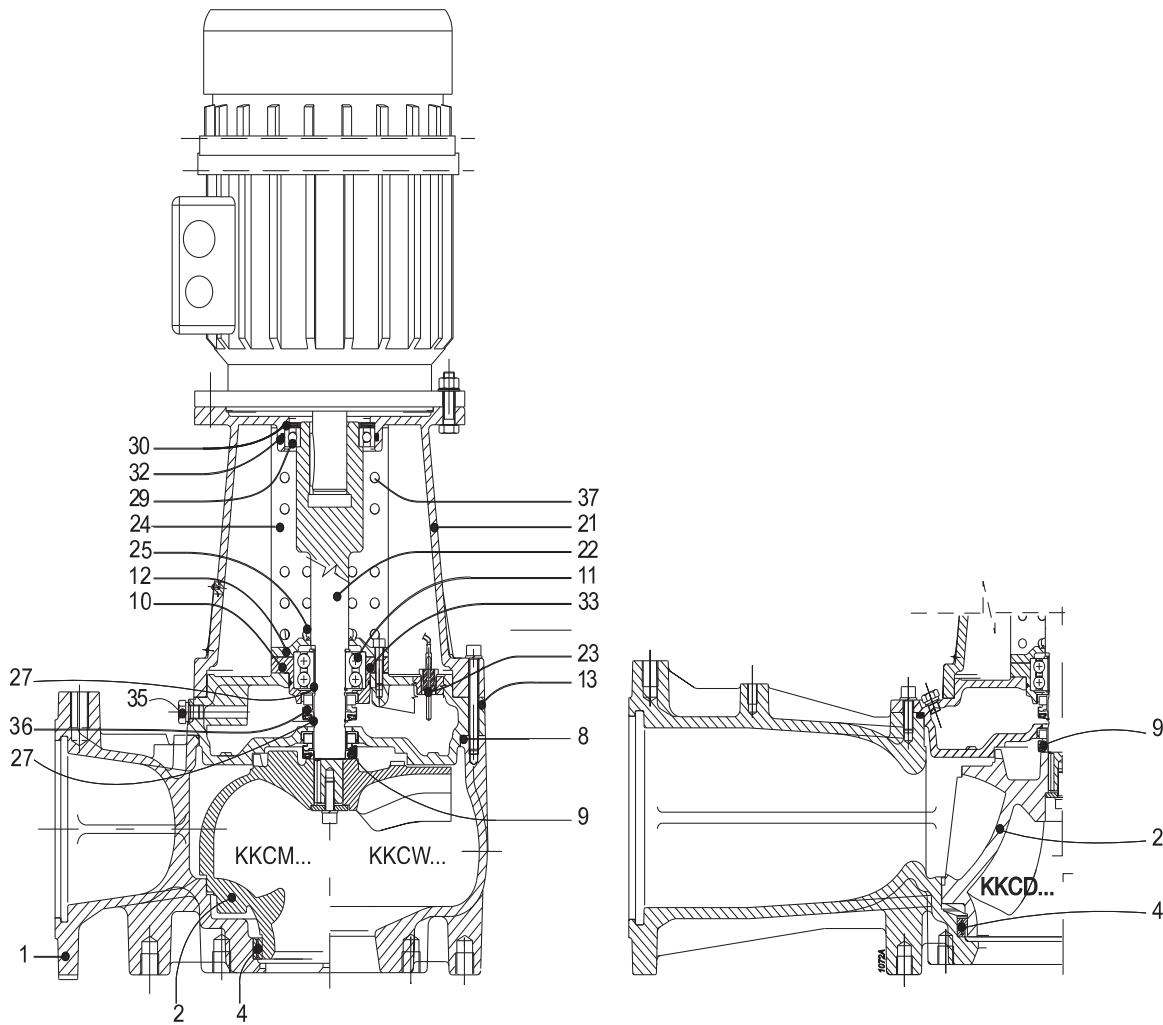

Pos.	Parts	Materials	Nomenclature	Matériaux	Nomenclatura	Materiale
1	Delivery body	Cast iron	Corps de refoulement	Fonte grise	Corpo mandata	Ghisa grigia
2	Impeller	Cast iron	Roue	Fonte grise	Girante	Ghisa grigia
4	Wear ring	Steel/Rubber	Bague d'usure	Acier/Caoutchouc	Anello sede girante	Acciaio/Gomma
8 - 32 - 33	OR Seal ring	Rubber	Bague d'étanchéité OR	Caoutchouc	Anello di tenuta OR	Gomma
9	Mechanical seal on pump side	Silicon carbide/silicon carbide	Garniture mécanique côté pompe	Carbure de silicium/ carbure de silicium	Tenuta meccanica lato pompa	Carburo di silicio/ carburo di silicio
10	Bearing support	Cast iron	Support de roulement	Fonte grise	Supporto cuscinetto	Ghisa grigia
11 - 29	bearing	-	roulement	-	Cuscinetto	-
12	Flange bearing	Cast iron	Bride roulement	Fonte grise	Flangia cuscinetto	Ghisa grigia
13	Oil box	Cast iron	Chambre à huile	Fonte grise	Scatola olio	Ghisa grigia
21	Lantern bracket	Cast iron	Lanterne support	Fonte grise	Supporto di collegamento	Ghisa grigia
22	Pump shaft	Stainless steel	Arbre de pompe	Acier inox	Albero pompa	Acciaio inox
23	Conductivity probe	Brass	Sondes de conductivité	Laiton	Sonda di conduttività	Ottone
24	Protective casing	Stainless steel	Carter de protection	Acier inox	Carter di protezione	Acciaio inox
25	Seal ring	Rubber	Bague d'étanchéité	Caoutchouc	Anello di tenuta	Gomma
27	Elastic ring	Steel	Circlip	Acier	Anello elastico	Acciaio
30	Belleville washer	Stainless steel	Rondelle Belleville	Acier inox	Molla a tazza	Acciaio inox
35	Plug	Stainless steel	Bouchon	Acier inox	Tappo	Acciaio inox
36	Mechanical seal on motor side	Stainless steel/graphite	Garniture mécanique côté moteur	Acier inox/graphite	Tenuta meccanica lato motore	Acciaio inox/grafite
37	Probe holder	Rubber	Porte-sonde	Caoutchouc	Porta sondino	Gomma

Screws and nuts in stainless steel.
Sondativity probe in the motor casing

Vis et écrous en acier inox.
Sonde de conductivité dans l'enveloppe du moteur

Viti e dadi in acciaio inox.
Sonda di conduttività nella carcassa motore

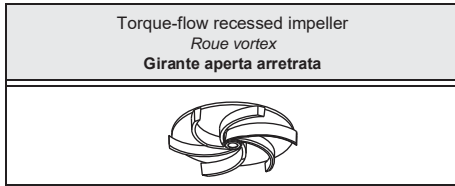

Type Type Tipo	KKCW100N.+...N3	
Conductivity probe Sonde de conductivité Sonda di conduttività	Yes Oui Sì	

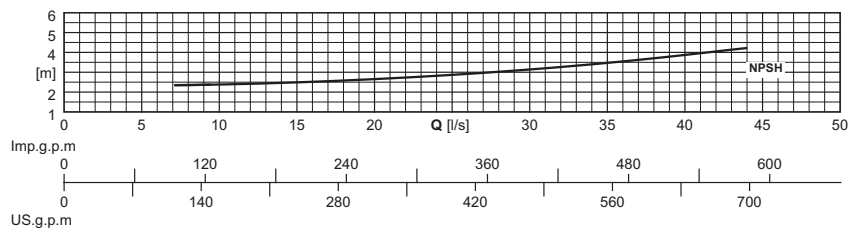
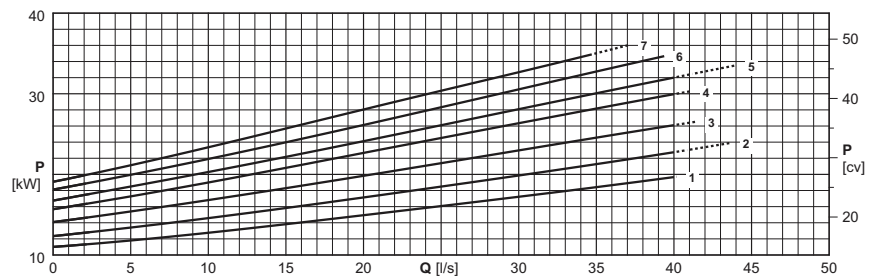
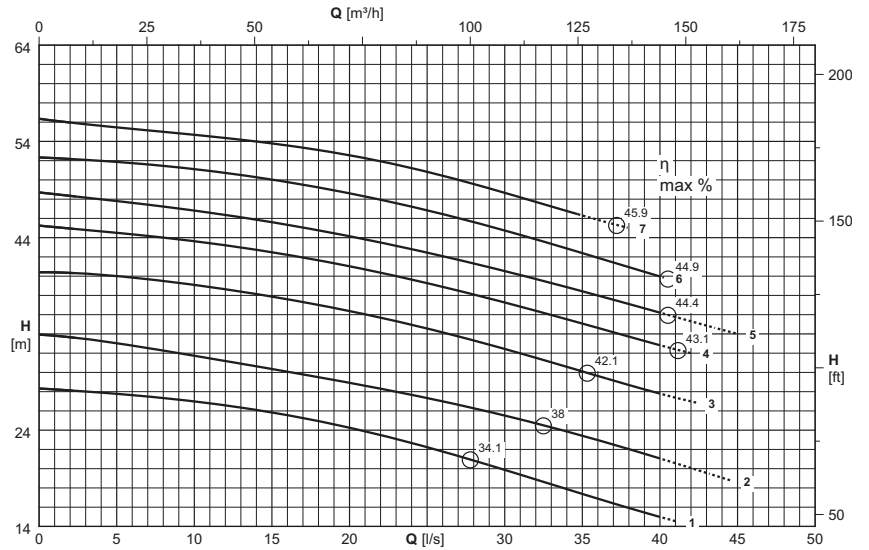

Electric pump type <i>Electropompe type</i> Elettropompa tipo	Curve <i>Courbe</i> Curva	Motor power <i>Puiss. moteur</i> Potenza motore	Capacity <i>Debit</i> Portata													
			[l/s]	0	5	10	15	20	25	30	35	40	45			
	(N°)	[kW]	[m³/h]	0	18	36	54	72	90	108	126	144	162			
			Head <i>Hauteur</i> Prevalenza													
			[m]	28,3	27,8	27	25,8	24,2	22,2	19,9	17,4	15				
KKCW100NL+022022N3	1	22	[m]	28,3	27,8	27	25,8	24,2	22,2	19,9	17,4	15				
KKCW100NI+030022N3	2	30	[m]	33,9	33	31,7	30,4	28,9	27,3	25,5	23,4	21,1				
KKCW100NH+030022N3	3	30	[m]	40,4	40	39,1	37,9	36,4	34,6	32,4	30,1	27,8				
KKCW100NG+037022N3	4	37	[m]	45,3	44,5	43,6	42,5	41	39,3	37,3	35,1	32,8				
KKCW100NF+037022N3	5	37	[m]	48,7	47,8	46,8	45,6	44,1	42,4	40,5	38,4	36,2	34			
KKCW100NE+037022N3	6	37	[m]	52,3	51,9	51,1	50	48,6	46,8	44,7	42,4	40				
KKCW100ND+037022N3	7	37	[m]	56,4	55,5	54,7	53,8	52,6	50,8	48,7	46,3					
NPSH _R			[m]			2,4	2,5	2,7	2,9	3,1	3,7	4				

P₂ = Power rated by the motor

Performance tolerance as per:
UNI/ISO 9906 Grade 3B

For the accessories specification see page "Accessories"

The hatched part of the curve represents the out-of-range of operation.

The impellers will be trimmed to meet the duty point

The performance values refer to units with Caprari motors.

P₂ = Puissance restituée par le moteur

Tolérances sur les performances selon normes:
UNI/ISO 9906 Niveau 3B

Pour les accessoires voir page "Accessories"

La partie pointillée de la courbe indique l'utilisation hors de la plage.

Le point de fonctionnement désiré peut être obtenu par rognage de roue

Les performances se réfèrent à des groupes avec moteurs Caprari.

P₂ = Potenza resa dal motore

Tolleranze sulle prestazioni secondo norme:
UNI/ISO 9906 Grado 3B

Per accessori vedere pagina accessori

La parte tratteggiata della curva rappresenta il fuori campo di utilizzo.

Le giranti vengono tornite in modo da ottenere il punto di lavoro richiesto

Le prestazioni sono riferite a gruppi con motori Caprari.

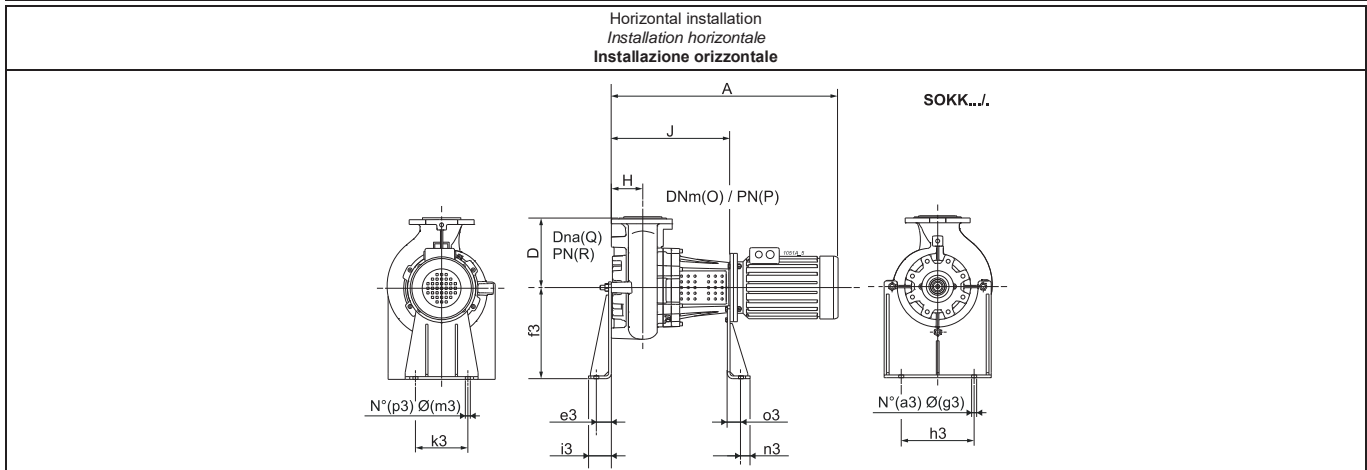
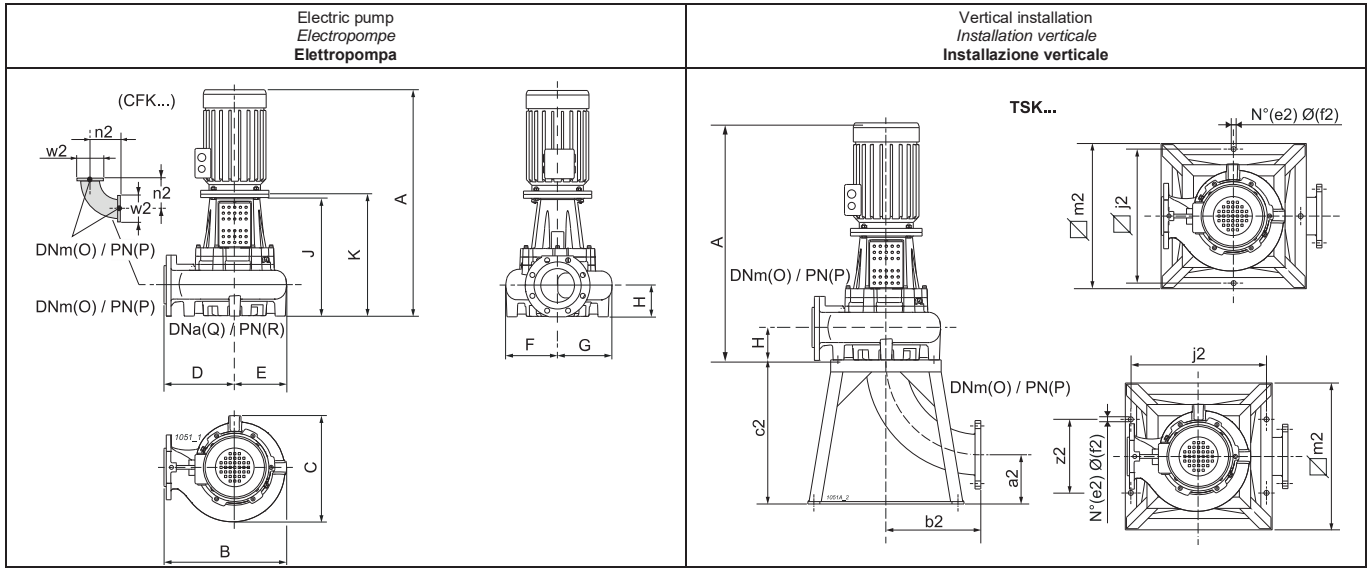

Type Type Tipo	Free passage Passage libre Passaggio Libero	Weight Poids Peso	[mm]																
			A	B	C	D	E	F	G	H	J	K	O	P	Q	R	a2	a3	b2
KKCW100NL+022022N3	Ø 80	250	1225	553	400	335	218	200	200	110	604	625	100	16	100	16	135	2	204
KKCW100NI+030022N3	Ø 80	302	1363	553	400	335	218	200	200	110	634	655	100	16	100	16	135	2	204
KKCW100NH+030022N3	Ø 80	302	1363	553	400	335	218	200	200	110	634	655	100	16	100	16	135	2	204
KKCW100NG+037022N3	Ø 80	316	1363	553	400	335	218	200	200	110	634	655	100	16	100	16	135	2	204
KKCW100NF+037022N3	Ø 80	316	1363	553	400	335	218	200	200	110	634	655	100	16	100	16	135	2	204
KKCW100NE+037022N3	Ø 80	317	1363	553	400	335	218	200	200	110	634	655	100	16	100	16	135	2	204
KKCW100ND+037022N3	Ø 80	317	1363	553	400	335	218	200	200	110	634	655	100	16	100	16	135	2	204

Type Type Tipo	[mm]																		
	c2	e2	e3	f2	f3	g3	h3	i3	j2	k3	m2	m3	n2	n3	o3	p3	w2	z2	
KKCW100NL+022022N3	340	4	66	22	400	22	320	100	600	230	650	22	204	40	48	2	220	600	
KKCW100NI+030022N3	340	4	66	22	400	22	320	100	600	230	650	22	204	40	48	2	220	600	
KKCW100NH+030022N3	340	4	66	22	400	22	320	100	600	230	650	22	204	40	48	2	220	600	
KKCW100NG+037022N3	340	4	66	22	400	22	320	100	600	230	650	22	204	40	48	2	220	600	
KKCW100NF+037022N3	340	4	66	22	400	22	320	100	600	230	650	22	204	40	48	2	220	600	
KKCW100NE+037022N3	340	4	66	22	400	22	320	100	600	230	650	22	204	40	48	2	220	600	
KKCW100ND+037022N3	340	4	66	22	400	22	320	100	600	230	650	22	204	40	48	2	220	600	

For the accessories specification see page "Accessories"

Pour les accessoires voir page "Accessories"

Per accessori vedere pagina accessori

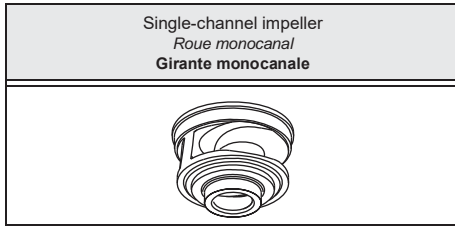

Type Type Tipo	KKCM100N.+...N3	
Conductivity probe Sonde de conductivité Sonda di conduttività	Yes Oui Sì	

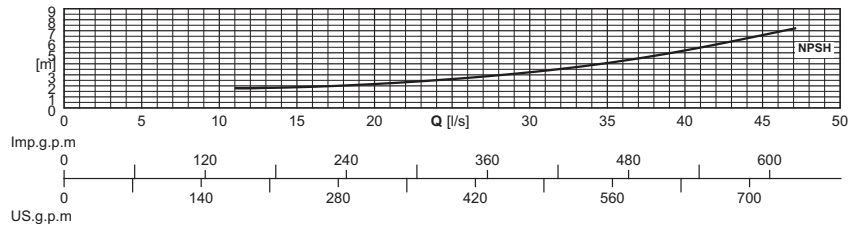
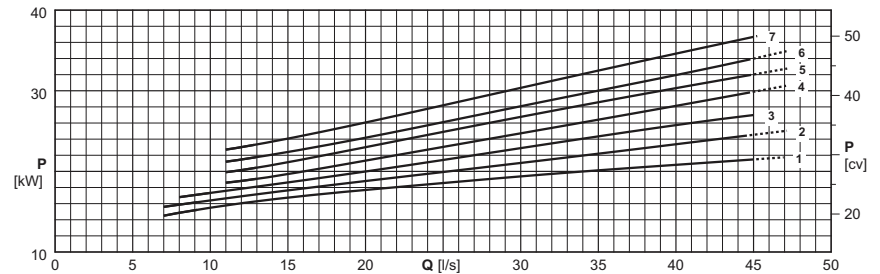
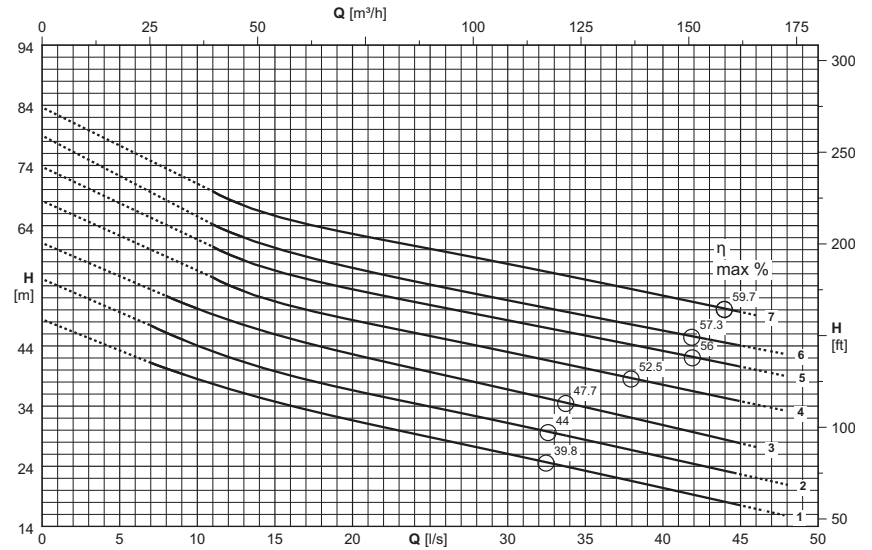

Electric pump type <i>Electropompe type</i> Elettropompa tipo	Curve <i>Courbe</i> Curva	Motor power <i>Puiss. moteur</i> Potenza motore	Capacity <i>Debit</i> Portata													
			[l/s]	0	10	15	20	25	30	35	40	45	50			
	(N°)	[kW]	[m³/h]	0	36	54	72	90	108	126	144	162	180			
			Head <i>Hauteur</i> Prevalenza													
			[m]	48,4	38,5	34,8	31,6	28,8	26,1	23,3	20,4	17,5				
KKCM100NG+022022N3	1	22	[m]	48,4	38,5	34,8	31,6	28,8	26,1	23,3	20,4	17,5				
KKCM100NF+030022N3	2	30	[m]	55,1	44,1	39,8	36,6	33,9	31,2	28,4	25,5	22,7				
KKCM100NE+030022N3	3	30	[m]	61,1	50,2	46	42,6	39,7	36,8	33,8	30,9	27,8				
KKCM100ND+030022N3	4	30	[m]	68,1	-	51,4	48,3	45,7	43	40,3	37,5	34,8				
KKCM100NC+037022N3	5	37	[m]	73,8	-	56,6	53,4	50,8	48,3	45,7	43,2	40,6				
KKCM100NB+037022N3	6	37	[m]	79	-	60,3	57	54,2	51,6	49,1	46,6	44,1				
KKCM100NA+037022N3	7	37	[m]	83,7	-	65,7	62,6	60,1	57,6	55	52,4	49,7				
NPSH _R			[m]			1,9	2,3	2,6	3,2	4,1	5,7	6,5				

P₂ = Power rated by the motor

Performance tolerance as per:
UNI/ISO 9906 Grade 3B

For the accessories specification see page "Accessories"

The hatched part of the curve represents the out-of-range of operation.

The performance values refer to units with Caprari motors.

P₂ = Puissance restituée par le moteur

Tolérances sur les performances selon normes:
UNI/ISO 9906 Niveau 3B

Pour les accessoires voir page "Accessories"

La partie pointillée de la courbe indique l'utilisation hors de la plage.

Les performances se réfèrent à des groupes avec moteurs Caprari.

P₂ = Potenza resa dal motore

Tolleranze sulle prestazioni secondo norme:
UNI/ISO 9906 Grado 3B

Per accessori vedere pagina accessori

La parte tratteggiata della curva rappresenta il fuori campo di utilizzo.

Le prestazioni sono riferite a gruppi con motori Caprari.

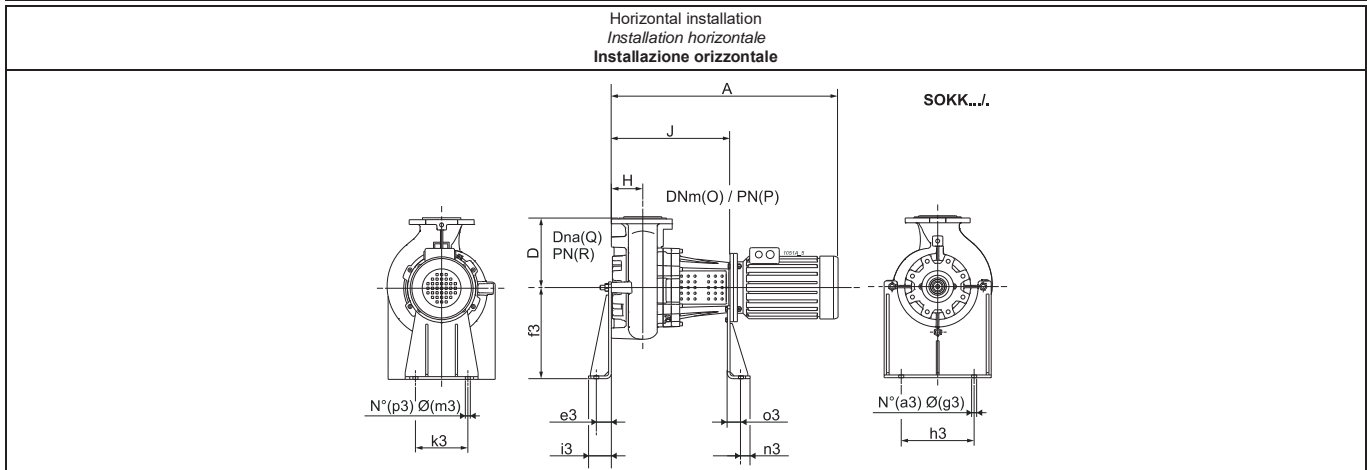
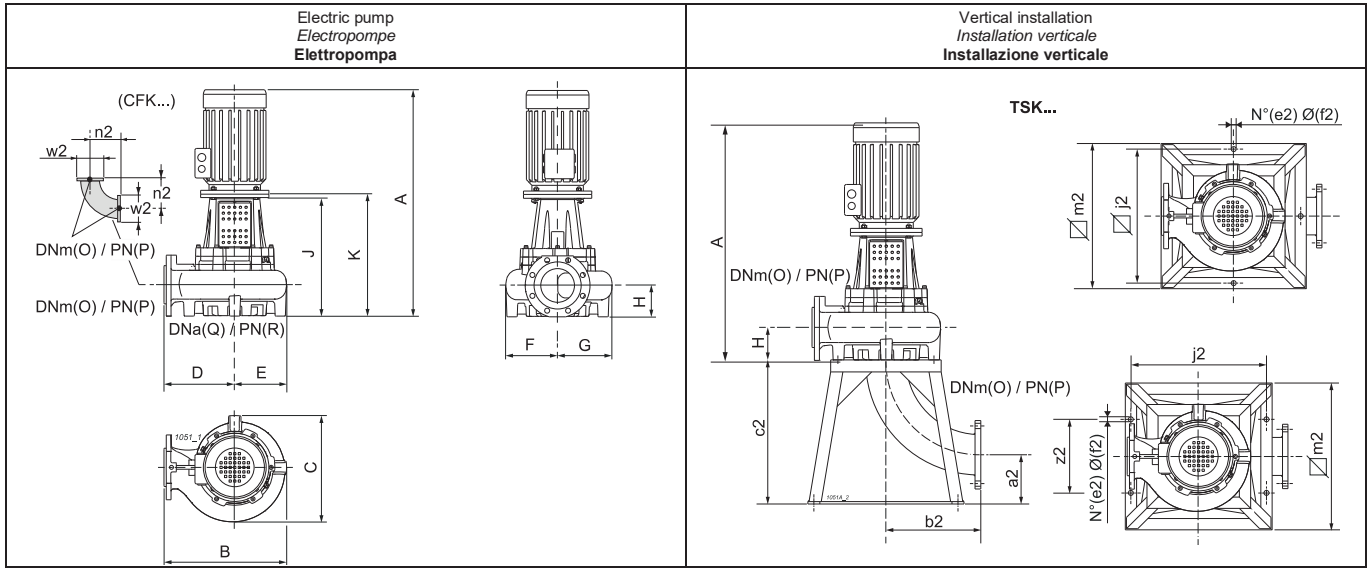

Type Type Tipo	Free passage Passage libre Passaggio Libero	Weight Poids Peso	[mm]																
			A	B	C	D	E	F	G	H	J	K	O	P	Q	R	a2	a3	b2
KKCM100NG+022022N3	Ø 80	297	1225	553	400	335	218	200	200	110	604	625	100	16	100	16	135	2	204
KKCM100NF+030022N3	Ø 80	316	1363	553	400	335	218	200	200	110	634	655	100	16	100	16	135	2	204
KKCM100NE+030022N3	Ø 80	317	1363	553	400	335	218	200	200	110	634	655	100	16	100	16	135	2	204
KKCM100ND+030022N3	Ø 80	318	1363	553	400	335	218	200	200	110	634	655	100	16	100	16	135	2	204
KKCM100NC+037022N3	Ø 80	329	1363	553	400	335	218	200	200	110	634	655	100	16	100	16	135	2	204
KKCM100NB+037022N3	Ø 80	329	1363	553	400	335	218	200	200	110	634	655	100	16	100	16	135	2	204
KKCM100NA+037022N3	Ø 80	330	1363	553	400	335	218	200	200	110	634	655	100	16	100	16	135	2	204
Type Type Tipo	c2	e2	e3	f2	f3	g3	h3	i3	j2	k3	m2	m3	n2	n3	o3	p3	w2	z2	
	[mm]																		
KKCM100NG+022022N3	340	4	66	22	400	22	320	100	600	230	650	22	204	40	48	2	220	600	
KKCM100NF+030022N3	340	4	66	22	400	22	320	100	600	230	650	22	204	40	48	2	220	600	
KKCM100NE+030022N3	340	4	66	22	400	22	320	100	600	230	650	22	204	40	48	2	220	600	
KKCM100ND+030022N3	340	4	66	22	400	22	320	100	600	230	650	22	204	40	48	2	220	600	
KKCM100NC+037022N3	340	4	66	22	400	22	320	100	600	230	650	22	204	40	48	2	220	600	
KKCM100NB+037022N3	340	4	66	22	400	22	320	100	600	230	650	22	204	40	48	2	220	600	
KKCM100NA+037022N3	340	4	66	22	400	22	320	100	600	230	650	22	204	40	48	2	220	600	

For the accessories specification see page "Accessories"

Pour les accessoires voir page "Accessories"

Per accessori vedere pagina accessori

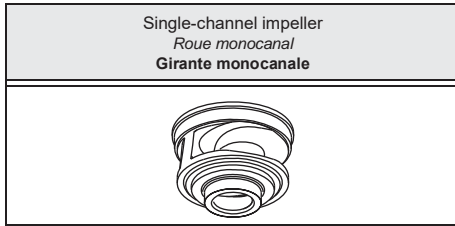

Type Type Tipo	KKCM150N.+...N3	
Conductivity probe Sonde de conductivité Sonda di conduttività	Yes Oui Sì	

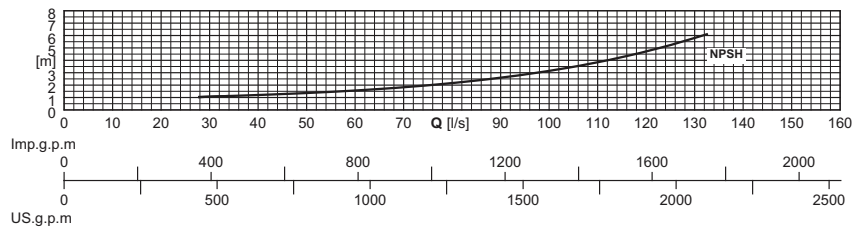
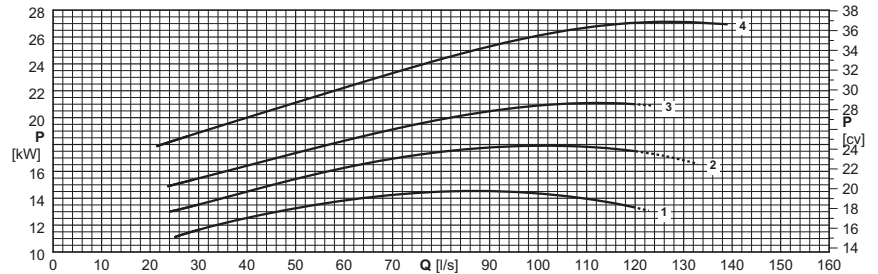
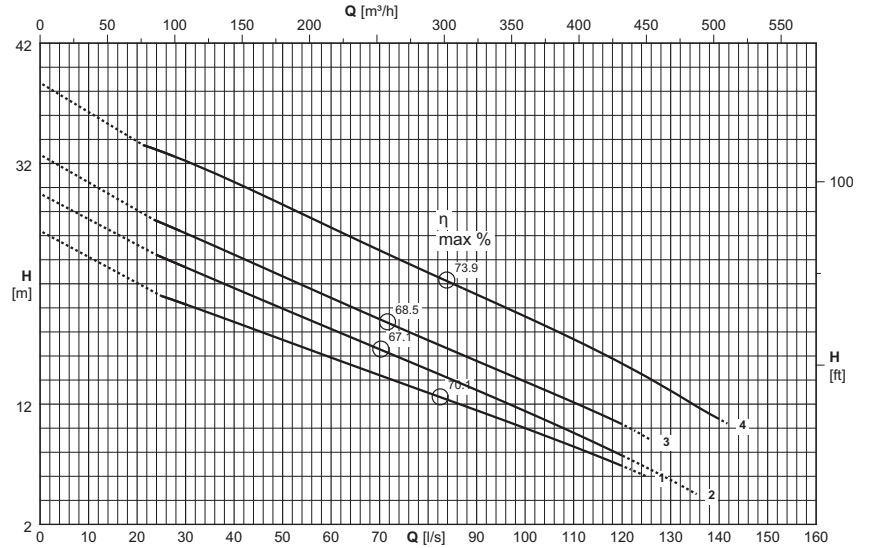

Electric pump type <i>Electropompe type</i> Elettropompa tipo	Curve <i>Courbe</i> Curva	Motor power <i>Puiss. moteur</i> Potenza motore	Capacity <i>Debit</i> Portata														
			[l/s]	0	28	42	56	70	84	98	112	126	140	154			
		P ₂	[m³/h]	0	101	151	202	252	302	353	403	454	504	554			
	(N°)	[kW]	Head <i>Hauteur</i> Prevalenza														
KKCM150NL+015042N3	1	15	[m]	26,4	20,6	18,5	16,5	14,4	12,4	10,3	8,2						
KKCM150NG+018542N3	2	18,5	[m]	29,5	23,7	21,3	18,9	16,6	14,2	11,8	9,2	6,5					
KKCM150ND+022042N3	3	22	[m]	32,7	26,5	24,1	21,5	19,1	16,6	14,2	11,8	9					
KKCM150NA+030042N3	4	30	[m]	38,7	32,5	30,1	27,4	24,8	22,2	19,7	17	14	10,8				
NPSH _R			[m]		1	1,2	1,5	1,9	2,9	3	4	5,6					

P₂ = Power rated by the motor

Performance tolerance as per:
UNI/ISO 9906 Grade 3B

For the accessories specification see page "Accessories"

The hatched part of the curve represents the out-of-range of operation.

The performance values refer to units with Caprari motors.

P₂ = Puissance restituée par le moteur

Tolérances sur les performances selon normes:
UNI/ISO 9906 Niveau 3B

Pour les accessoires voir page "Accessories"

La partie pointillée de la courbe indique l'utilisation hors de la plage.

Les performances se réfèrent à des groupes avec moteurs Caprari.

P₂ = Potenza resa dal motore

Tolleranze sulle prestazioni secondo norme:
UNI/ISO 9906 Grado 3B

Per accessori vedere pagina accessori

La parte tratteggiata della curva rappresenta il fuori campo di utilizzo.

Le prestazioni sono riferite a gruppi con motori Caprari.

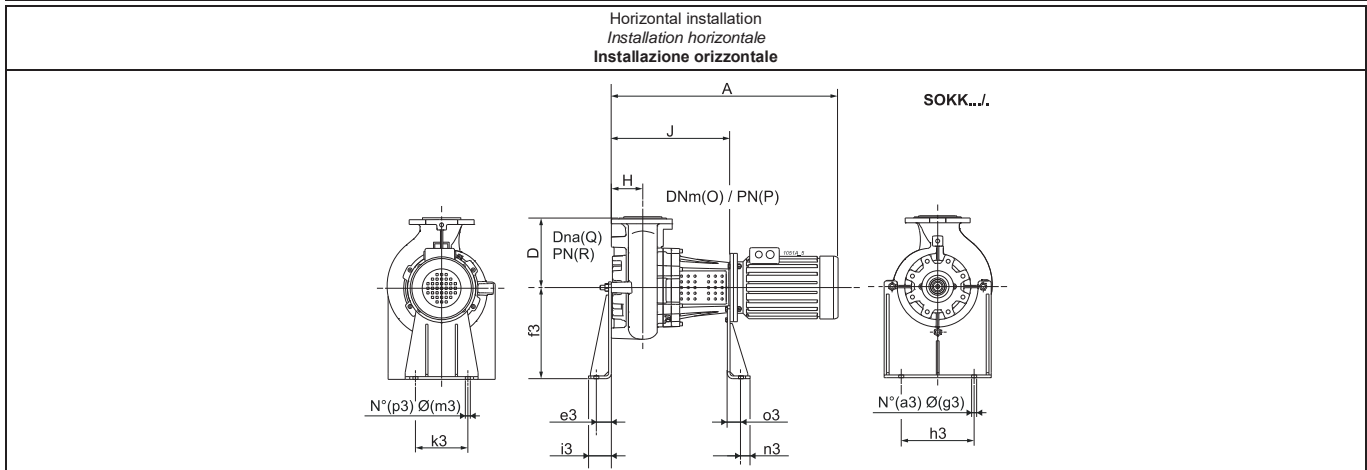
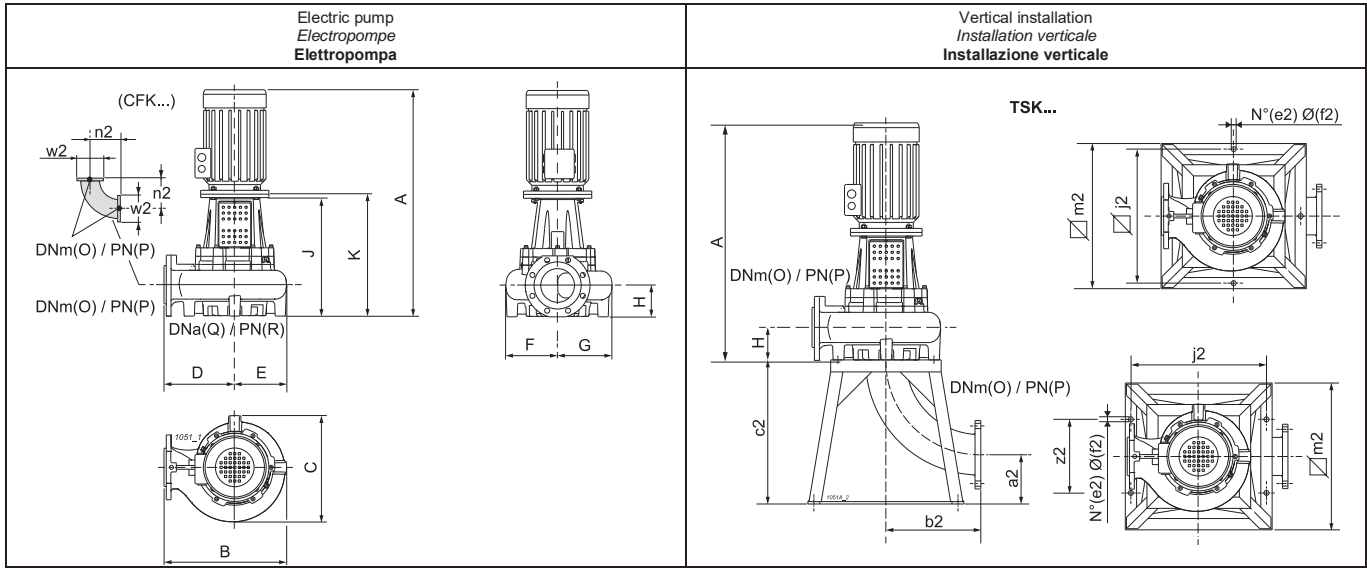

Type Type Tipo	Free passage Passage libre Passaggio Libero	Weight Poids Peso	A	B	C	D	E	F	G	H	J	K	O	P	Q	R	a2	a3	b2
	[mm]	[kg]	[mm]																
KKCM150NL+015042N3	Ø 115	318	1252	658	508	405	253	230	278	160	661	682	150	16	150	16	205	2	395
KKCM150NG+018542N3	Ø 115	336	1282	658	508	405	253	230	278	160	661	682	150	16	150	16	205	2	395
KKCM150ND+022042N3	Ø 115	353	1342	658	508	405	253	230	278	160	661	682	150	16	150	16	205	2	395
KKCM150NA+030042N3	Ø 115	376	1440	658	508	405	253	230	278	160	691	712	150	16	150	16	205	2	395
Type Type Tipo	c2	e2	e3	f2	f3	g3	h3	i3	j2	k3	m2	m3	n2	n3	o3	p3	w2	z2	
	[mm]																		
KKCM150NL+015042N3	600	4	66	22	400	22	320	100	600	230	650	22	395	40	48	2	285	600	
KKCM150NG+018542N3	600	4	66	22	400	22	320	100	600	230	650	22	395	40	48	2	285	600	
KKCM150ND+022042N3	600	4	66	22	400	22	320	100	600	230	650	22	395	40	48	2	285	600	
KKCM150NA+030042N3	600	4	66	22	400	22	320	100	600	230	650	22	395	40	48	2	285	600	

For the accessories specification see page "Accessories"

Pour les accessoires voir page "Accessories"

Per accessori vedere pagina accessori

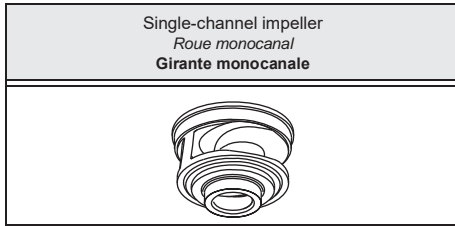

Type Type Tipo	KKCM200P...+...N3	
Conductivity probe Sonde de conductivité Sonda di conduttività	Yes Oui Sì	

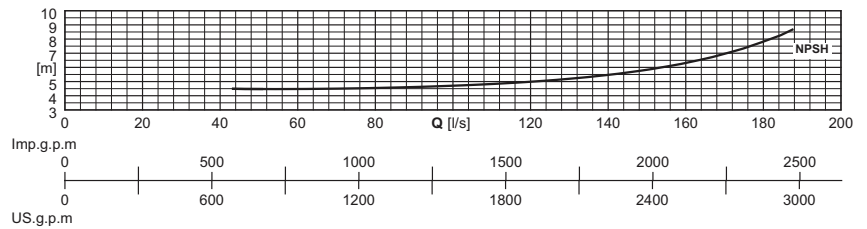
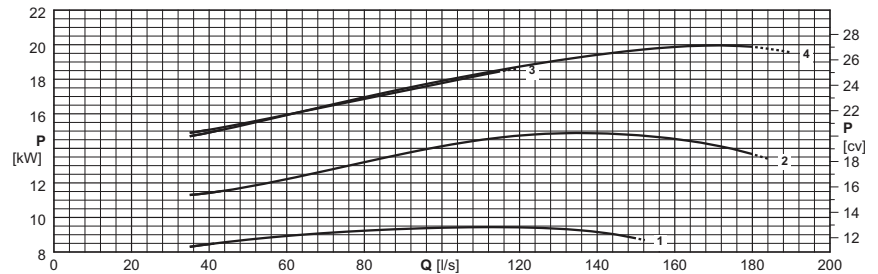
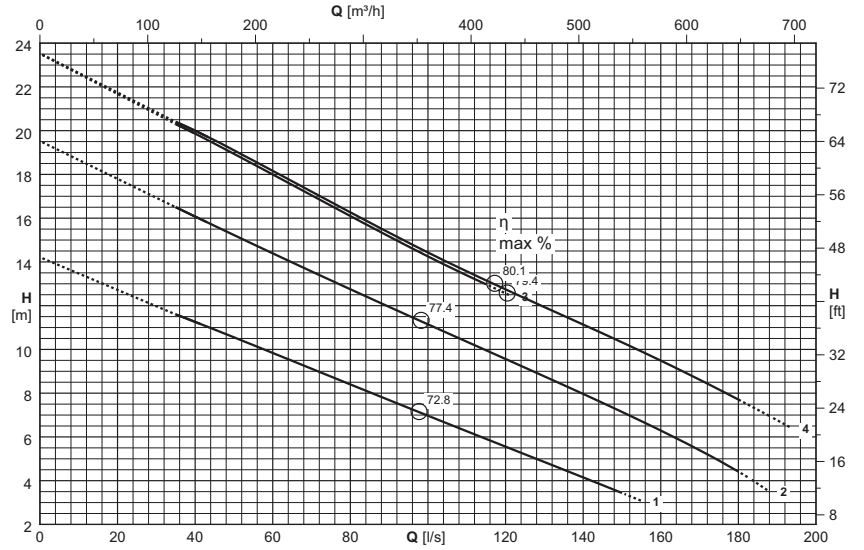

Electric pump type <i>Electropompe type</i> Elettropompa tipo	Curve <i>Courbe</i> Curva	Motor power <i>Puiss. moteur</i> Potenza motore	Capacity <i>Debit</i> Portata														
			[l/s]	0	38	57	76	95	114	133	152	171	190	209			
		P ₂	[m³/h]	0	137	205	274	342	410	479	547	616	684	752			
	(N°)	[kW]	Head <i>Hauteur</i> Prevalenza														
KKCM200PG+011062N3	1	11	[m]	14,2	11,4	10,1	8,7	7,3	6	4,6	3,3						
KKCM200PD+015062N3	2	15	[m]	19,5	16,2	14,6	13,1	11,5	10	8,5	7	5,3					
KKCM200PA+018562N3	3	18,5	[m]	23,5	20	18,3	16,5	14,7	13,1								
KKCM200PA+022062N3	4	22	[m]	23,5	20,2	18,4	16,6	14,9	13,2	11,7	10,2	8,5	6,8				
NPSH _R			[m]			4,5	4,5	4,7	5	5,3	6	6,8					

P₂ = Power rated by the motor
Performance tolerance as per:
UNI/ISO 9906 Grade 3B
For the accessories specification see page "Accessories"
The hatched part of the curve represents the out-of-range of operation.
The performance values refer to units with Caprari motors.

P₂ = Puissance restituée par le moteur
Tolérances sur les performances selon normes:
UNI/ISO 9906 Niveau 3B
Pour les accessoires voir page "Accessories"
La partie pointillée de la courbe indique l'utilisation hors de la plage.
Les performances se réfèrent à des groupes avec moteurs Caprari.

P₂ = Potenza resa dal motore
Tolleranze sulle prestazioni secondo norme:
UNI/ISO 9906 Grado 3B
Per accessori vedere pagina accessori
La parte tratteggiata della curva rappresenta il fuori campo di utilizzo.
Le prestazioni sono riferite a gruppi con motori Caprari.

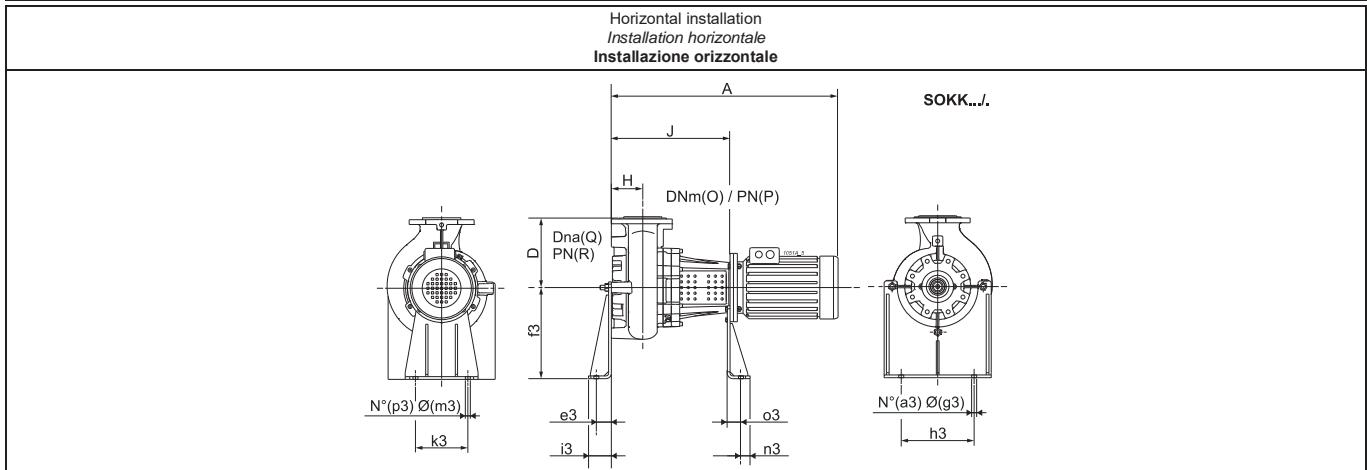
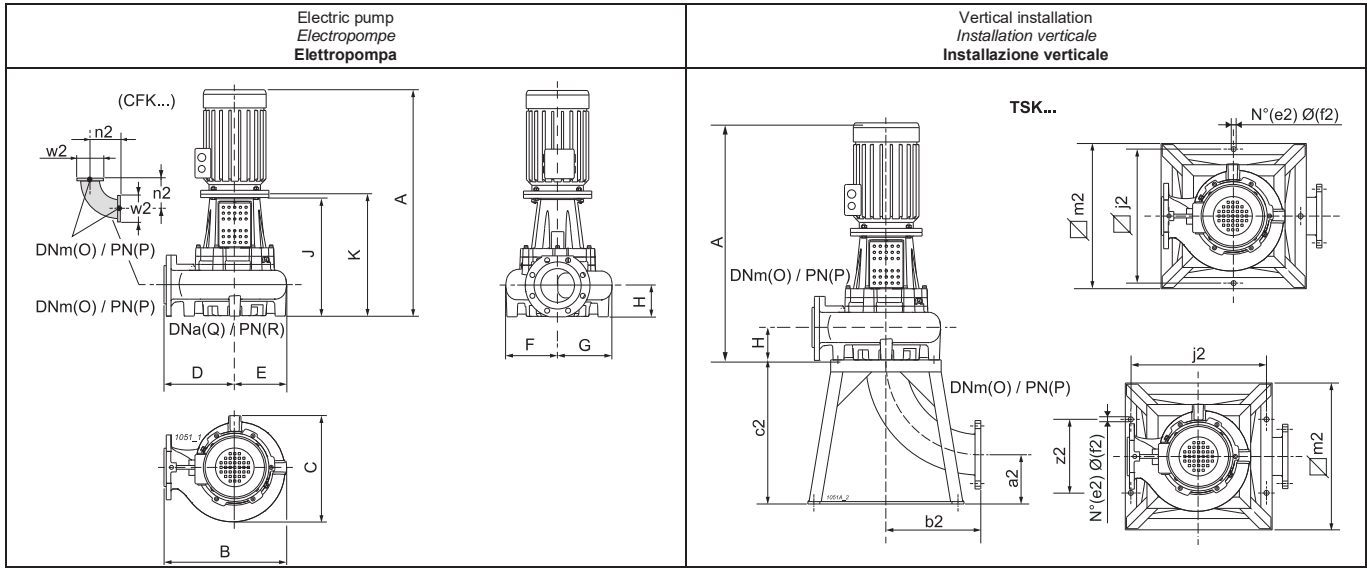

Type Type Tipo	Free passage Passage libre Passaggio Libero	Weight Poids Peso	A	B	C	D	E	F	G	H	J	K	O	P	Q	R	a2	a3	b2
	[mm]	[kg]	[mm]																
KKCM200PG+011062N3	Ø 135	310	1292	765	615	455	310	275	340	185	701	722	200	10	200	10	300	2	310
KKCM200PD+015062N3	Ø 135	360	1382	765	615	455	310	275	340	185	701	722	200	10	200	10	300	2	310
KKCM200PA+018562N3	Ø 135	427	1480	765	615	455	310	275	340	185	731	752	200	10	200	10	300	2	310
KKCM200PA+022062N3	Ø 135	478	1480	765	615	455	310	275	340	185	731	752	200	10	200	10	300	2	310
Type Type Tipo	c2	e2	e3	f2	f3	g3	h3	i3	j2	k3	m2	m3	n2	n3	o3	p3	w2	z2	
	[mm]																		
KKCM200PG+011062N3	600	4	66	22	400	22	320	100	600	230	650	22	310	40	48	2	340	600	
KKCM200PD+015062N3	600	4	66	22	400	22	320	100	600	230	650	22	310	40	48	2	340	600	
KKCM200PA+018562N3	600	4	66	22	400	22	320	100	600	230	650	22	310	40	48	2	340	600	
KKCM200PA+022062N3	600	4	66	22	400	22	320	100	600	230	650	22	310	40	48	2	340	600	

For the accessories specification see page "Accessories"

Pour les accessoires voir page "Accessories"

Per accessori vedere pagina accessori

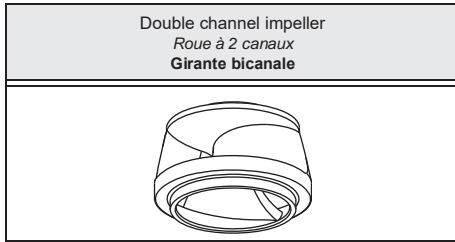

Type Type Tipo	KKCD200N...+...N3	
Conductivity probe Sonde de conductivité Sonda di conduttività	Yes Oui Sì	

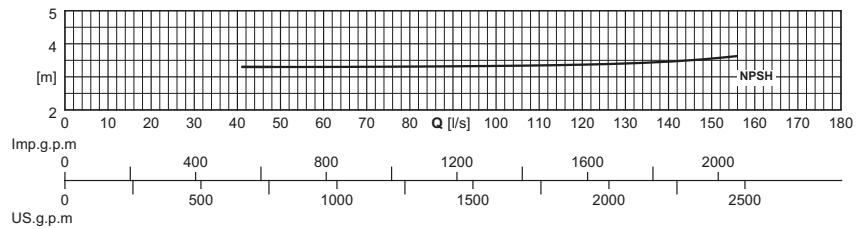
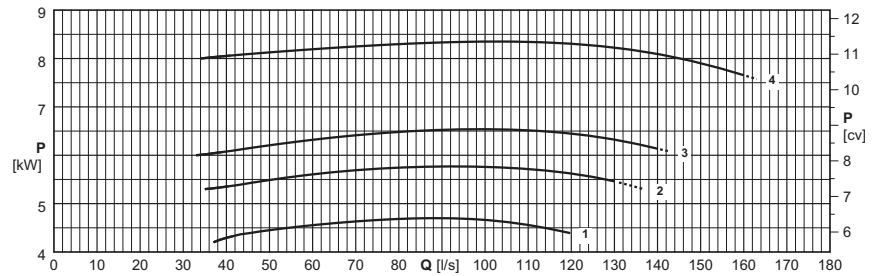
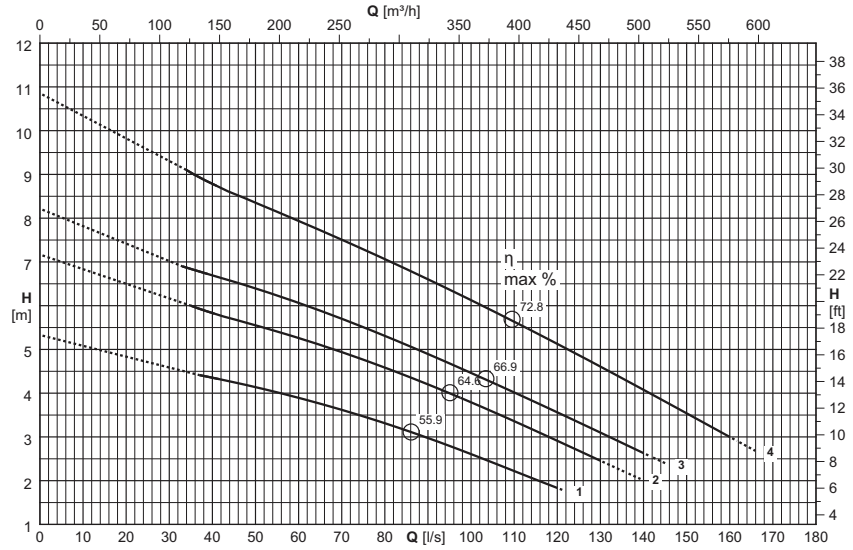

Electric pump type Electropompe type Elettropompa tipo	Curve Courbe Curva	Motor power Puiss. moteur Potenza motore	Capacity Débit Portata													
			[l/s]	0	34	51	68	85	102	119	136	153	170			
		P ₂	[m³/h]	0	122	184	245	306	367	428	490	551	612			
	(N°)	[kW]	Head Hauteur Prevalenza													
			[m]	5,3	-	4,1	3,7	3,1	2,5	1,9						
KKCD200NL+007562N3	1	7,5	[m]	5,3	-	4,1	3,7	3,1	2,5	1,9						
KKCD200NG+007562N3	2	7,5	[m]	7,2	-	5,5	5	4,4	3,7	3	2,2					
KKCD200ND+007562N3	3	7,5	[m]	8,2	6,9	6,4	5,8	5,1	4,4	3,6	2,8					
KKCD200NA+011062N3	4	11	[m]	10,9	9,1	8,3	7,6	6,8	6	5,2	4,3	3,4				
NPSH _R			[m]			3,3	3,3	3,3	3,3	3,4	3,4	3,6				

P₂ = Power rated by the motor

Performance tolerance as per:
UNI/ISO 9906 Grade 3B

For the accessories specification see page "Accessories"

The hatched part of the curve represents the out-of-range of operation.

The performance values refer to units with Caprari motors.

P₂ = Puissance restituée par le moteur

Tolérances sur les performances selon normes:
UNI/ISO 9906 Niveau 3B

Pour les accessoires voir page "Accessories"

La partie pointillée de la courbe indique l'utilisation hors de la plage.

Les performances se réfèrent à des groupes avec moteurs Caprari.

P₂ = Potenza resa dal motore

Tolleranze sulle prestazioni secondo norme:
UNI/ISO 9906 Grado 3B

Per accessori vedere pagina accessori

La parte tratteggiata della curva rappresenta il fuori campo di utilizzo.

Le prestazioni sono riferite a gruppi con motori Caprari.

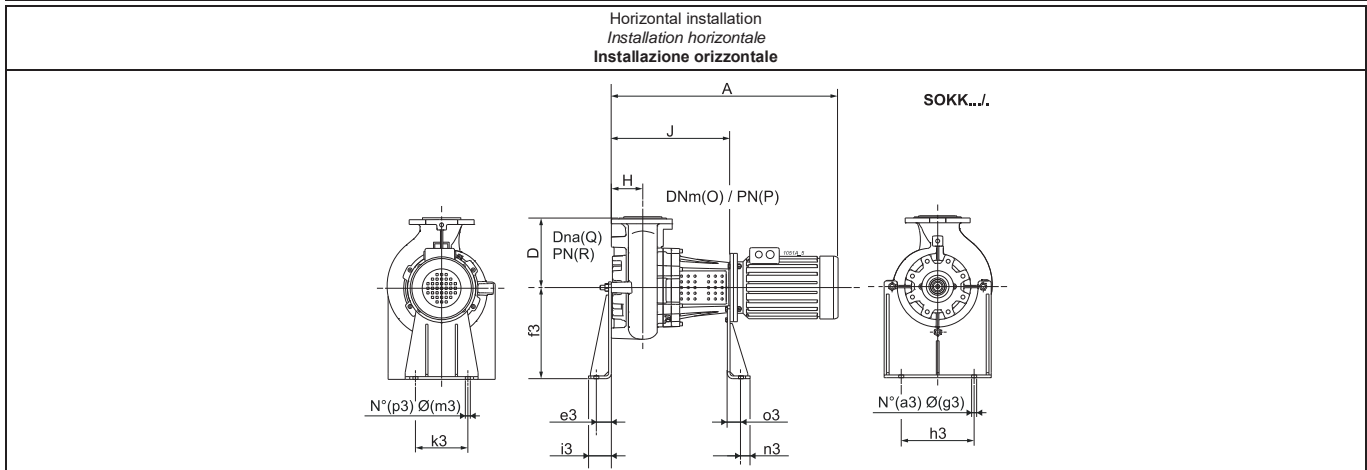
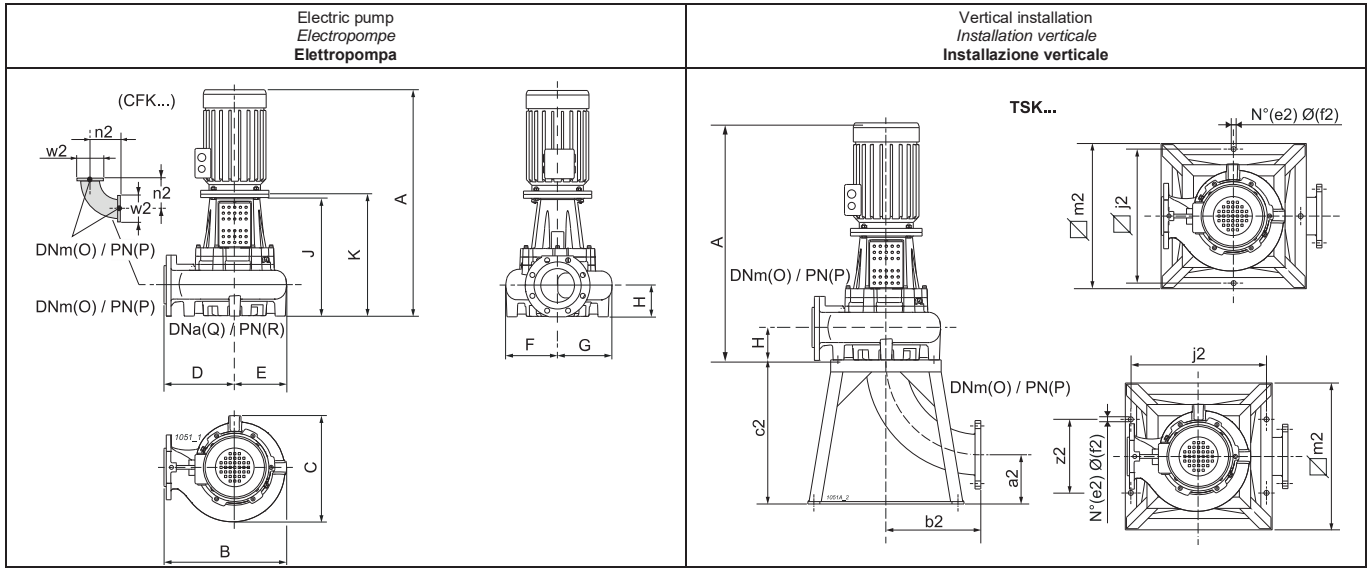

Type Type Tipo	Free passage Passage libre Passaggio Libero	Weight Poids Peso	A	B	C	D	E	F	G	H	J	K	O	P	Q	R	a2	a3	b2
			[mm]	[kg]	[mm]														
KKCD200NL+007562N3	Ø 100 x 110	347	1271	840	580	550	290	240	340	170	680	701	200	10	200	10	300	2	310
KKCD200NG+007562N3	Ø 100 x 110	348	1271	840	580	550	290	240	340	170	680	701	200	10	200	10	300	2	310
KKCD200ND+007562N3	Ø 100 x 110	349	1271	840	580	550	290	240	340	170	680	701	200	10	200	10	300	2	310
KKCD200NA+011062N3	Ø 100 x 110	347	1271	840	580	550	290	240	340	170	680	701	200	10	200	10	300	2	310
Type Type Tipo	c2	e2	e3	f2	f3	g3	h3	i3	j2	k3	m2	m3	n2	n3	o3	p3	w2	z2	
	[mm]																		
KKCD200NL+007562N3	600	4	66	22	400	22	320	100	600	230	650	22	310	40	48	2	340	600	
KKCD200NG+007562N3	600	4	66	22	400	22	320	100	600	230	650	22	310	40	48	2	340	600	
KKCD200ND+007562N3	600	4	66	22	400	22	320	100	600	230	650	22	310	40	48	2	340	600	
KKCD200NA+011062N3	600	4	66	22	400	22	320	100	600	230	650	22	310	40	48	2	340	600	

For the accessories specification see page "Accessories"

Pour les accessoires voir page "Accessories"

Per accessori vedere pagina accessori

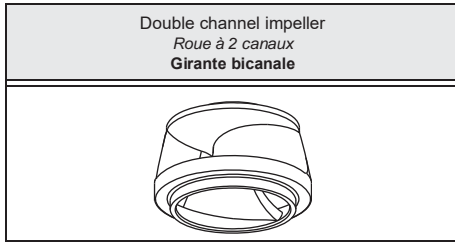

Type Type Tipo	KKCD200N...+...N3	
Conductivity probe Sonde de conductivité Sonda di conduttività	Yes Oui Sì	

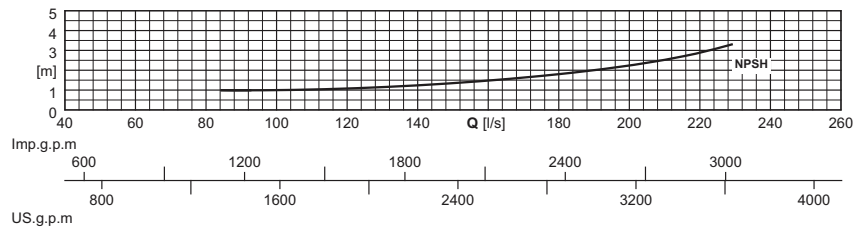
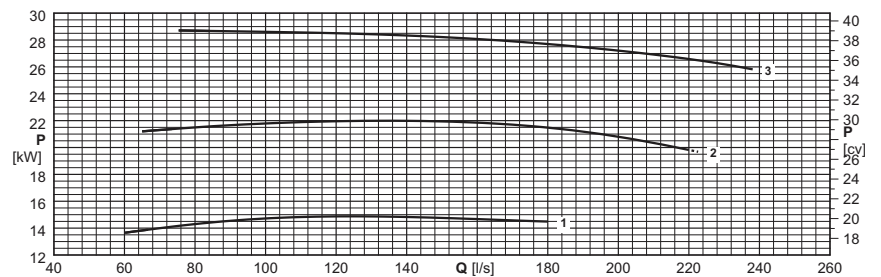
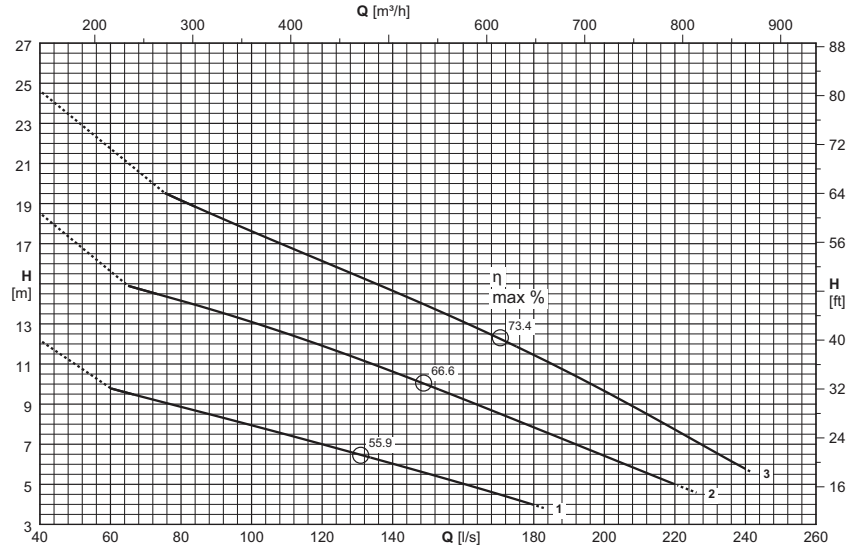

Electric pump type Electropompe type Elettropompa tipo	Curve Courbe Curva	Motor power Puiss. moteur Potenza motore	Capacity Debit Portata												
			[l/s]	0	72	96	120	144	168	192	216	240	264		
	(N°)	[kW]	[m³/h]	0	259	346	432	518	605	691	778	864	950		
			Head Hauteur Prevalenza												
			[m]	12,2	9,2	8,1	7	5,8	4,6						
KKCD200NP+015042N3	1	15	[m]	12,2	9,2	8,1	7	5,8	4,6						
KKCD200ND+022042N3	2	22	[m]	18,5	14,6	13,3	11,9	10,4	8,7	7	5,3				
KKCD200NA+030042N3	3	30	[m]	24,6	-	17,9	16,1	14,3	12,5	10,4	8,1	5,8			
NPSH _R			[m]			1	1,1	1,3	1,6	2	2,7				

P_2 = Power rated by the motor
Performance tolerance as per:
UNI/ISO 9906 Grade 3B
For the accessories specification see page "Accessories"
The hatched part of the curve represents the out-of-range of operation.
The performance values refer to units with Caprari motors.

P_2 = Puissance restituée par le moteur
Tolérances sur les performances selon normes:
UNI/ISO 9906 Niveau 3B
Pour les accessoires voir page "Accessories"
La partie en pointillé de la courbe indique l'utilisation hors de la plage.
Les performances se réfèrent à des groupes avec moteurs Caprari.

P_2 = Potenza resa dal motore
Tolleranze sulle prestazioni secondo norme:
UNI/ISO 9906 Grado 3B
Per accessori vedere pagina accessori
La parte tratteggiata della curva rappresenta il fuori campo di utilizzo.
Le prestazioni sono riferite a gruppi con motori Caprari.

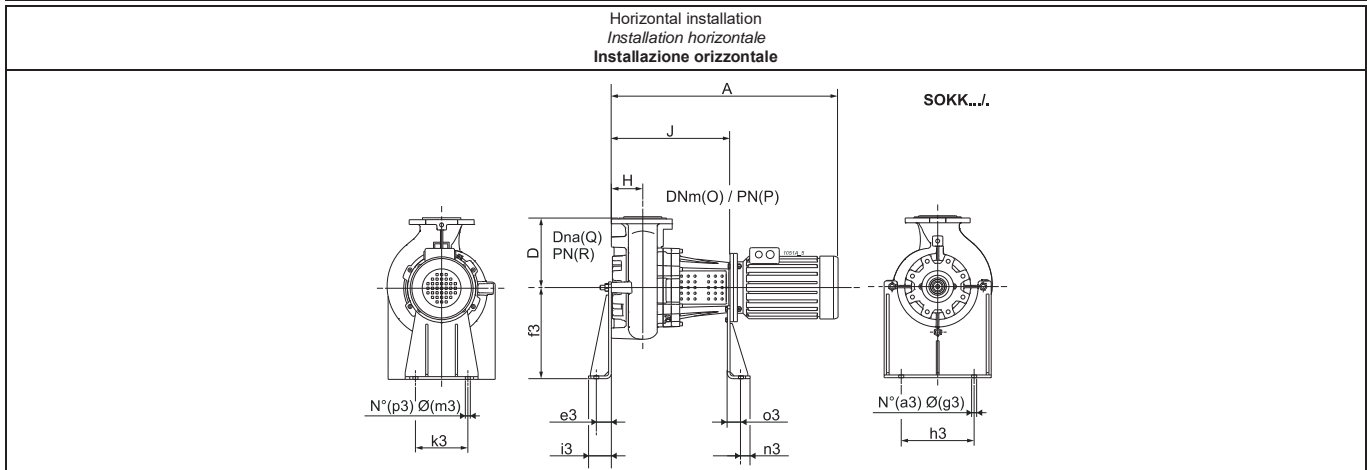
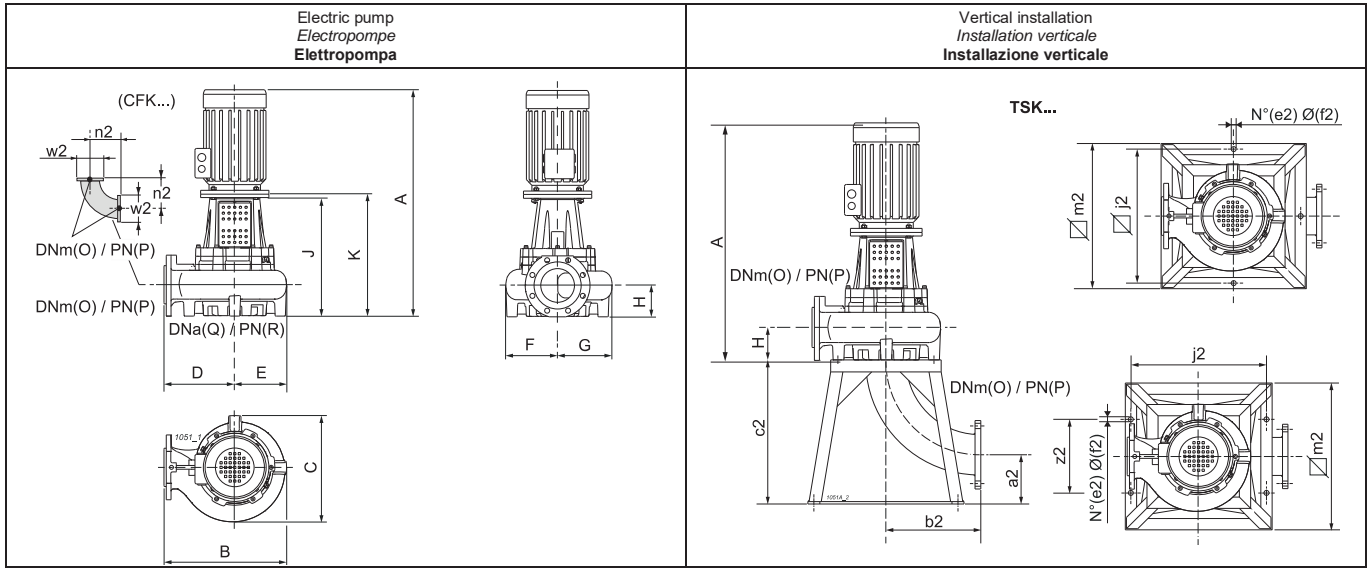

Type Type Tipo	Free passage Passage libre Passaggio Libero	Weight Poids Peso	A	B	C	D	E	F	G	H	J	K	O	P	Q	R	a2	a3	b2
			[mm]	[kg]	[mm]														
KKCD200NP+015042N3	Ø 100 x 110	384	1271	840	580	550	290	240	340	170	680	701	200	10	200	10	300	2	310
KKCD200ND+022042N3	Ø 100 x 110	350	1361	840	580	550	290	240	340	170	680	701	200	10	200	10	300	2	310
KKCD200NA+030042N3	Ø 100 x 110	408	1459	840	580	550	290	240	340	170	710	731	200	10	200	10	300	2	310
Type Type Tipo	c2	e2	e3	f2	f3	g3	h3	i3	j2	k3	m2	m3	n2	n3	o3	p3	w2	z2	
	[mm]																		
KKCD200NP+015042N3	600	4	66	22	400	22	320	100	600	230	650	22	310	40	48	2	340	600	
KKCD200ND+022042N3	600	4	66	22	400	22	320	100	600	230	650	22	310	40	48	2	340	600	
KKCD200NA+030042N3	600	4	66	22	400	22	320	100	600	230	650	22	310	40	48	2	340	600	

For the accessories specification see page "Accessories"

Pour les accessoires voir page "Accessories"

Per accessori vedere pagina accessori

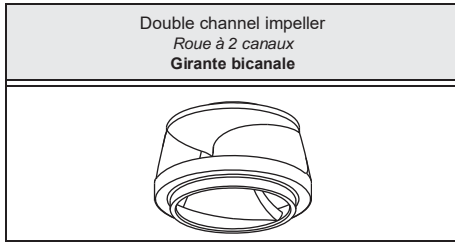

Type Type Tipo	KKCD250P...+...N3	
Conductivity probe Sonde de conductivité Sonda di conduttività	Yes Oui Sì	

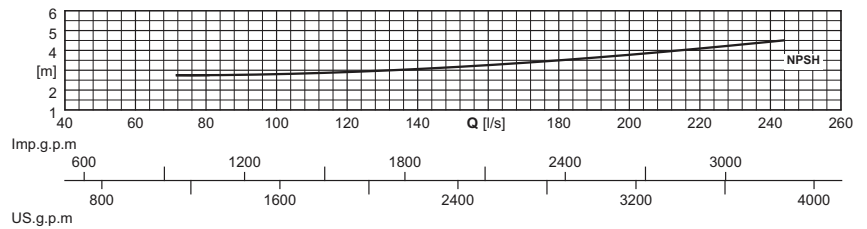
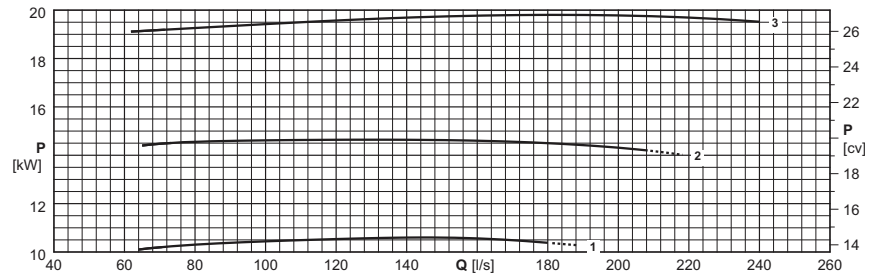
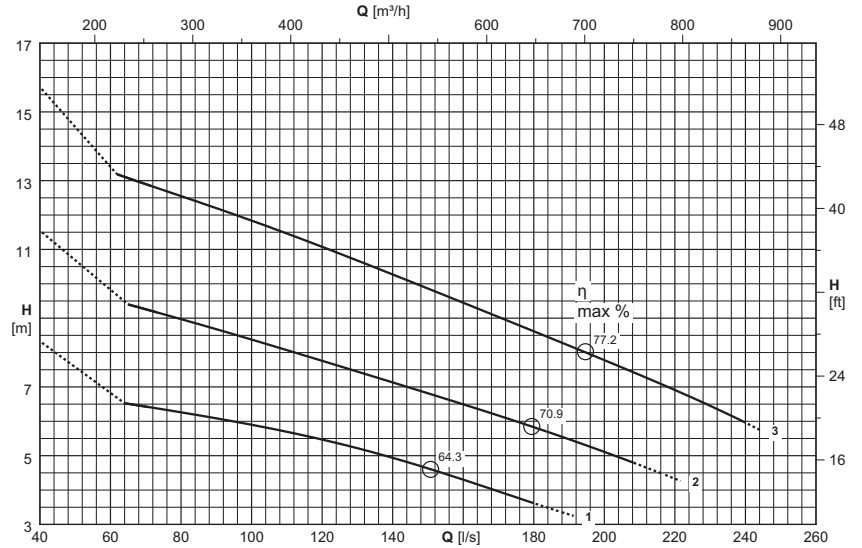

Electric pump type Electropompe type Elettropompa tipo	Curve Courbe Curva	Motor power Puiss. moteur Potenza motore	Capacity Debit Portata												
			[l/s]	0	75	100	125	150	175	200	225	250			
	(N°)	[kW]	[m³/h]	0	270	360	450	540	630	720	810	900			
			Head Hauteur Prevalenza												
			[m]	8,3	6,3	5,9	5,3	4,6	3,8						
KKCD250PG+011062N3	1	11	[m]	8,3	6,3	5,9	5,3	4,6	3,8						
KKCD250PD+015062N3	2	15	[m]	11,5	9,1	8,4	7,6	6,8	6	5,1					
KKCD250PA+022062N3	3	22	[m]	15,7	12,7	11,8	10,9	9,9	8,8	7,8	6,7				
NPSH _R			[m]		2,8	2,9	3	3,1	3,5	3,8	4,2				

P_2 = Power rated by the motor
Performance tolerance as per:
UNI/ISO 9906 Grade 3B
For the accessories specification see page "Accessories"
The hatched part of the curve represents the out-of-range of operation.
The performance values refer to units with Caprari motors.

P_2 = Puissance restituée par le moteur
Tolérances sur les performances selon normes:
UNI/ISO 9906 Niveau 3B
Pour les accessoires voir page "Accessories"
La partie pointillée de la courbe indique l'utilisation hors de la plage.
Les performances se réfèrent à des groupes avec moteurs Caprari.

P_2 = Potenza resa dal motore
Tolleranze sulle prestazioni secondo norme:
UNI/ISO 9906 Grado 3B
Per accessori vedere pagina accessori
La parte tratteggiata della curva rappresenta il fuori campo di utilizzo.
Le prestazioni sono riferite a gruppi con motori Caprari.

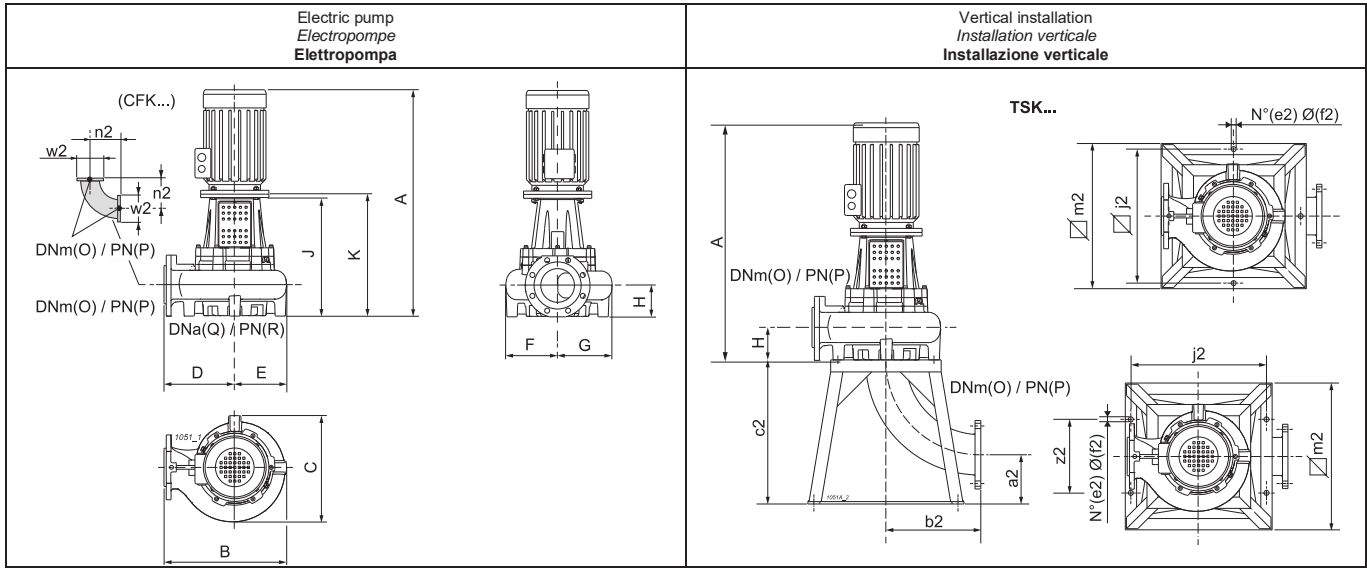

Horizontal installation
Installation horizontale
Installazione orizzontale

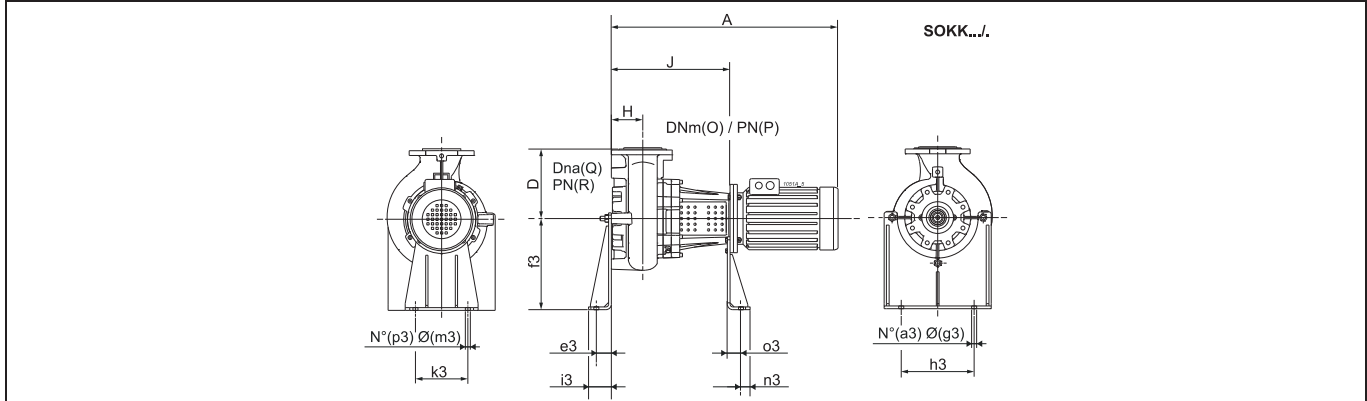

Type Type Tipo	Free passage Passage libre Passaggio Libero	Weight Poids Peso	A	B	C	D	E	F	G	H	J	K	O	P	Q	R	a2	a3	b2
			[mm]	[kg]	[mm]														
KKCD250PG+011062N3	Ø 115 x 130	345	1317	845	690	500	345	285	405	200	726	747	250	10	250	10	215	2	385
KKCD250PD+015062N3	Ø 115 x 130	395	1407	845	690	500	345	285	405	200	726	747	250	10	250	10	215	2	385
KKCD250PA+022062N3	Ø 115 x 130	513	1505	845	690	500	345	285	405	200	756	777	250	10	250	10	215	2	385
Type Type Tipo	c2	e2	e3	f2	f3	g3	h3	i3	j2	k3	m2	m3	n2	n3	o3	p3	w2	z2	
	[mm]																		
KKCD250PG+011062N3	600	4	66	22	400	22	375	100	600	230	650	22	385	40	48	2	395	600	
KKCD250PD+015062N3	600	4	66	22	400	22	375	100	600	230	650	22	385	40	48	2	395	600	
KKCD250PA+022062N3	600	4	66	22	400	22	375	100	600	230	650	22	385	40	48	2	395	600	

For the accessories specification see page "Accessories"

Pour les accessoires voir page "Accessories"

Per accessori vedere pagina accessori

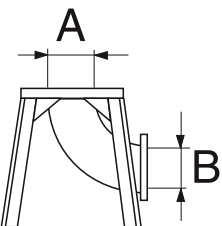
Base frame (dipped galvanized steel) Chassis de soutien (acier galvanisé) Telaio di sostegno (acciaio zincato a caldo)	Type Type Tipo	A		B		Weight Poids Peso [Kg]	Electric pump type Electropompe type Elettropompa tipo							
		DN	UNI PN	DN	UNI PN		KKCW100N	KKCM100N	KKCM150N	KKCM200P	KKCD200N	KKCD250P		
	TSK100A	100	16	100	16	34			-	-	-	-		
	TSK250A	250	10	250	10	85	-	-	-	-	-			
	TSK1A	150	16	150	16	50	-	-		-	-	-		
	TSKMA	200	10	200	10	70	-	-	-			-		

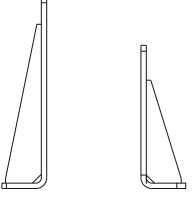
Supports (Steel with protective paint) Support de soutien (Acier revêtu de peinture de protection) Supporti (acciaio con vernice protettiva)	Type Type Tipo	Weight Poids Peso [Kg]	Electric pump type Electropompe type Elettropompa tipo							
			KKCW100N	KKCM100N	KKCM150N	KKCM200P	KKCD200N	KKCD250P		
	SOKK100/4	34,5	22	22	-	-	-	-		
	SOKK100/4/200	34	30-37	30-37	-	-	-	-		
	SOKK200/4	33,5	-	-	15-18,5-22	11-15	7,5-11-15-22	-		
	SOKK200/4/200	33,5	-	-	30	18,5-22	30	-		
	SOKK250/4	33	-	-	-	-	-	11-15		
	SOKK250/4/200	32,5	-	-	-	-	-	22		

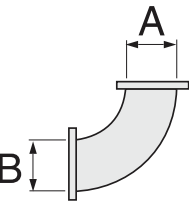
Flanged elbow (dipped galvanized steel) Coude bridé (acier galvanisé à chaud) Curva flangiata (acciaio zincato a caldo)	Type Type Tipo	A		B		Weight Poids Peso [Kg]	Electric pump type Electropompe type Elettropompa tipo					
		DN	UNI PN	DN	UNI PN		KKCW100N	KKCM100N	KKCM150N	KKCM200P	KKCD200N	KKCD250P
	CFK100	100	16	100	16	12			-	-	-	-
	CFK150	150	16	150	16	25,5	-	-		-	-	-
	CFK200	200	10	200	10	31	-	-	-			-
	CFK250	250	10	250	10	43,5	-	-	-	-	-	

Flanges (UNI EN 1092-2)
 Brides (UNI EN 1092-2)
 Flange (UNI EN 1092-2)

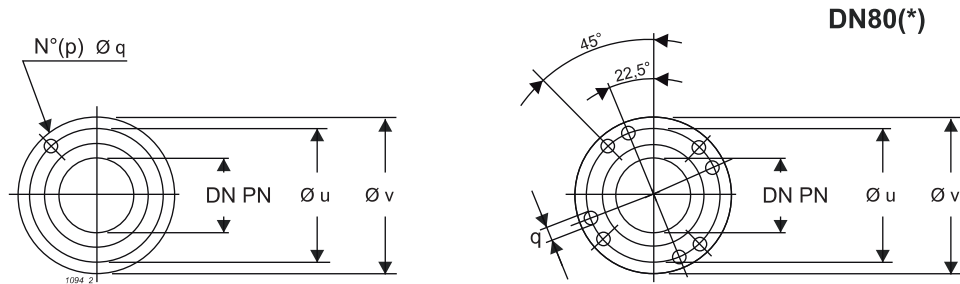

n°4 fori DN80 PN16 + n°4 fori ex DN80 PN10
 n°4 holes DN80 PN16 + n°4 holes ex DN80 PN10

Port ø ø Orifice ø Bocca	Holes Trous Fori		ø u	ø v
	p	q DNa - q DNm		
DN [mm] - PN [bar]	No	ø [mm]	[mm]	
DN80 - PN16	8	(-) - 18	160	200
DN80 - PN16 (*)	4	M16 - (-)	160	200
DN100 - PN16	8	M16 - 18	180	220
DN150 - PN16	8	M20 - 22	240	285
DN200 - PN10	8	M20 - 22	295	340
DN250 - PN10	12	M20 - 22	350	395



The dimensions have an indicative value. Executive drawing will be supplied on request upon order.
CAPRARI S.p.A. reserves the right to make changes to improve its products at any time and without any notice

*Les dimensions sont fournies à titre indicatif. Le plan bon pour exécution sera fourni sur demande au moment de la commande.
CAPRARI S.p.A. se réserve la faculté d'apporter des modifications visant à améliorer ses propres produits à tout moment et sans aucun préavis.*

**Le dimensioni hanno valore indicativo. Il disegno esecutivo sarà fornito su richiesta in fase d'ordine.
CAPRARI S.p.A. si riserva facoltà di apportare modifiche atte a migliorare i propri prodotti in qualsiasi momento e senza preavviso alcuno.**