

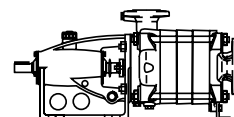

Multistage Pumps
with Horizontal Shaft
*Pompes Multicellulaires
à Axe Horizontal*
**Pompe Multistadio
ad Asse Orizzontale**



HMU

HMU

caprari

pumping power

The HMU series are multistage centrifugal pumps, horizontal, single suction, fitted with a heavy duty pedestal which gives to the machine the high rigidity necessary for coupling it to combustion engines.

The extended model range, the possibility of direct coupling to electric motors or to combustion engines, the availability of special constructions on demand are enabling offers for each of the different applications, the best solution for dependability, efficiency and energy saving.

Les pompes de la série HMU sont des pompes centrifuges multicellulaires à axe horizontal, à aspiration axiale, montées sur chaise-palier largement dimensionné, assurant la rigidité indispensable pour l'accouplement aux moteurs à combustion interne.

L'étendue de la gamme de production, la possibilité d'accouplement direct à des moteurs électriques ou à combustion interne, la disponibilité de constructions spéciales sur demande, permettent de proposer, pour toute utilisation différente, la meilleure solution en tant que fiabilité, rendement et économie d'énergie.

Le pompe della serie HMU sono pompe centrifughe multistadio ad asse orizzontale, a semplice aspirazione, dotate di un supporto a sedia ampiamente dimensionato che assicura una grande rigidità alla macchina, indispensabile per l'accoppiamento ai motori termici.

L'estensione della gamma di produzione, la possibilità di accoppiamento diretto a motori elettrici e termici, la disponibilità di esecuzioni speciali su richiesta permettono di proporre, per ogni diverso utilizzo, la soluzione ottimale dal punto di vista dell'affidabilità, del rendimento e, conseguentemente, dell'economia di esercizio.



CERTIFICATION FOR USE WITH DRINKING WATER: DM174, WRAS, ACS
CERTIFICATION POUR L'EMPLOI EN EAU POTABLE: DM174, WRAS, ACS
CERTIFICAZIONE PER L'IMPIEGO IN ACQUA POTABILE: DM174, WRAS, ACS



Electric pumping set - fixed installation
Groupe électropompe sur châssis pour installation fixe
Gruppo elettropompa su base per installazione fissa



- ☐ Radial impeller with axial thrust compensation.

Roues radiales avec dispositif pour la compensation de la poussée axiale.

Girante radiale con dispositivo di compensazione della spinta assiale.

- ☐ Support bearing stand, amply sized; serves as a base and support of the overhanged wet end: sturdiness.

Palier largement dimensionné et faisant fonction d'appui pour la fixation de l'ensemble et sur lequel la partie hydraulique est montée en porte-à faux : résistance.

Supporto a sedia, ampiamente dimensionato; funge da base di appoggio e sostiene a sbalzo la parte idraulica: robustezza.

- ☐ Shaft: guided and supported by two oil lubricated ball bearings housed in the bearing stand support. Bearings are amply sized for coupling to electric motors and endothermic engines by means of flexible coupling: ensure long life.

Arbre: guidé et soutenu par deux roulements à billes logés dans le support et lubrifiés à l'huile. Ils sont largement dimensionnés pour permettre l'entraînement par moteur électrique ou thermique par l'intermédiaire d'un accouplement élastique : garantit une longue vie.

Albero: guidato e sostenuto da due cuscinetti a sfere alloggiati nel supporto a sedia e lubrificati ad olio; essi sono largamente dimensionati a permettere l'accoppiamento sia a motore elettrico che endotermico a mezzo di giunto elastico: garanzia di durata.

- ☐ Seals usually adjustable packing, easily replaceable, housed in the delivery casing's packing gland chamber: simplify maintenance.

Garniture à tresse facilement remplaçable logée dans une chambre du corps de refoulement : simplifie la maintenance.

Tenuta a baderna registrabile, facilmente sostituibile: facilità di manutenzione.

APPLICATIONS
APPLICATIONS
APPLICAZIONI

aqueducts
adduction d'eau
acquedottistica

water supply
alimentation d'eau potable
alimentazione idrica ad uso civile

conditioning
conditionnement
condizionamento

industrial applications
installations industrielles
applicazioni industriali

fire-fighting
lutte anti-incendie
antincendio

leisure parks
equipements pour les loisirs
impianti per il tempo libero

irrigation
irrigation
irrigazione



Engine driven pumping set - mobile installation
Groupe motopompe pour installation mobile
Gruppo motopompa per installazione mobile

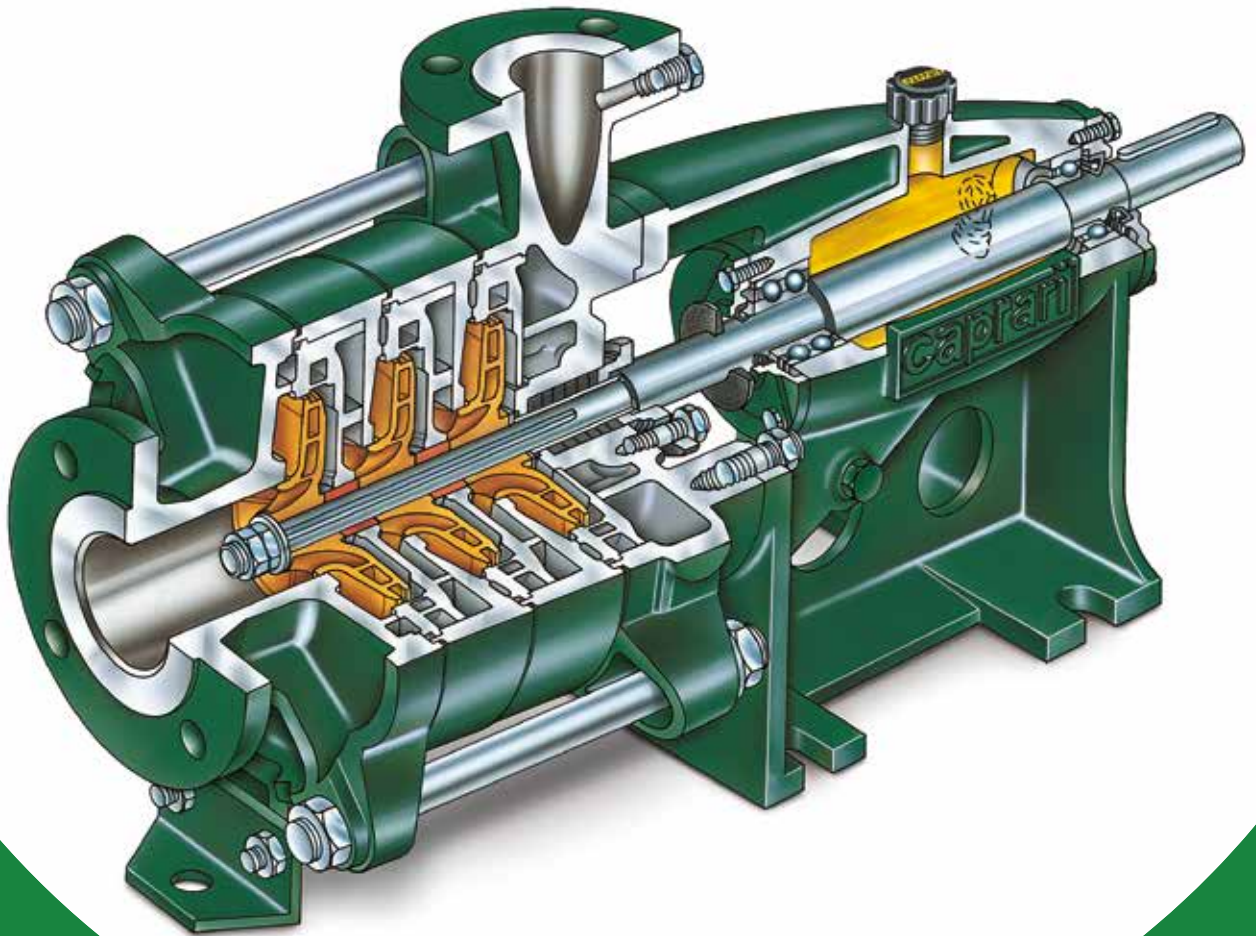

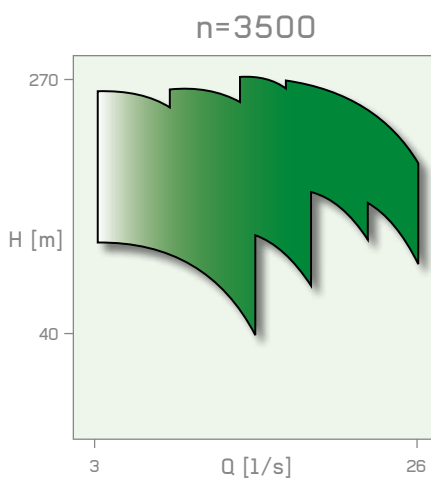
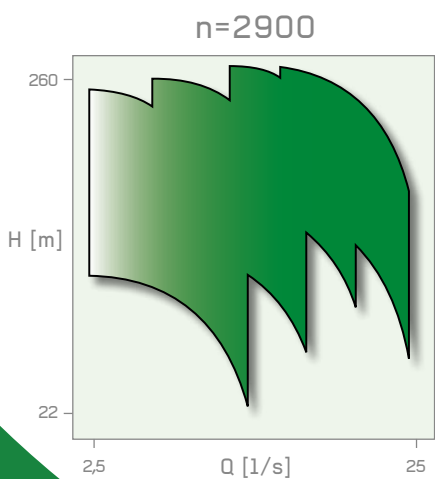
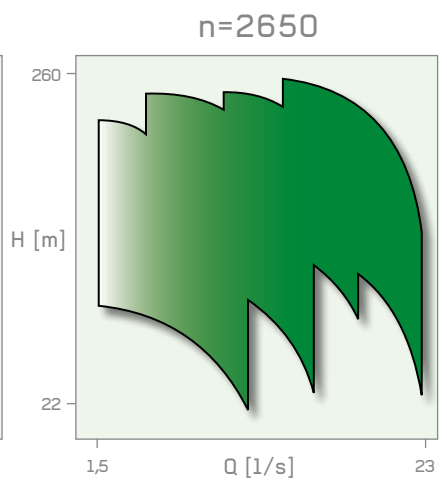
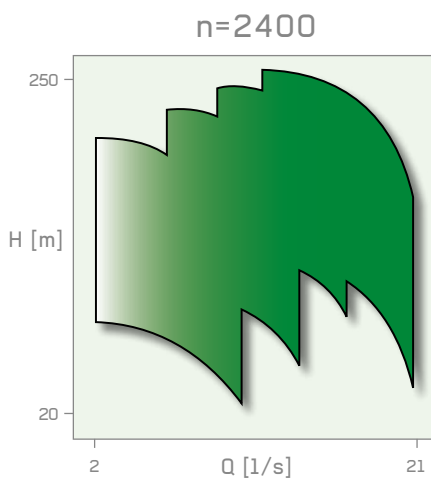
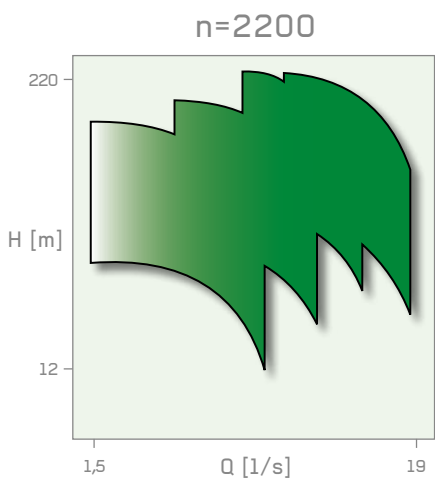
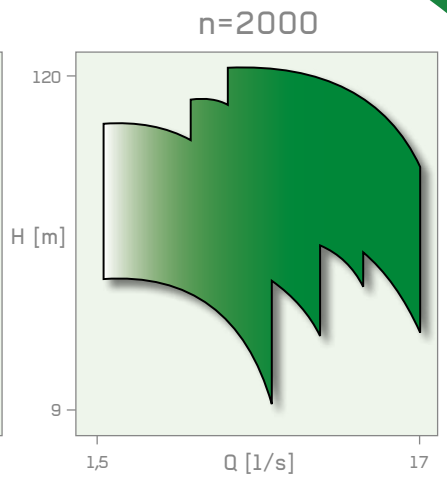
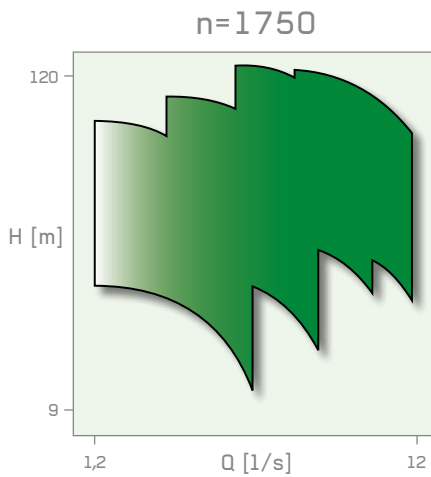
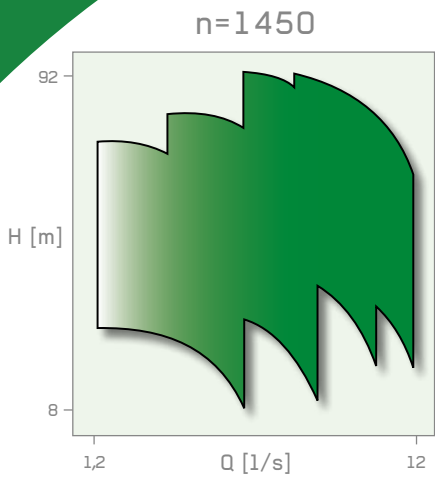

Special executions on demand:
Exécution spéciales sur demande:
Esecuzioni speciali a richiesta:

High pressure mechanical seal
Garniture mécanique haute pression

**Tenuta meccanica alta
 pressione**

Special mechanical seal
Garniture mécanique spéciale
Tenuta meccanica speciale

Outlet port in horizontal position
Orifice de refoulement en position horizontale
Bocca di mandata in posizione orizzontale

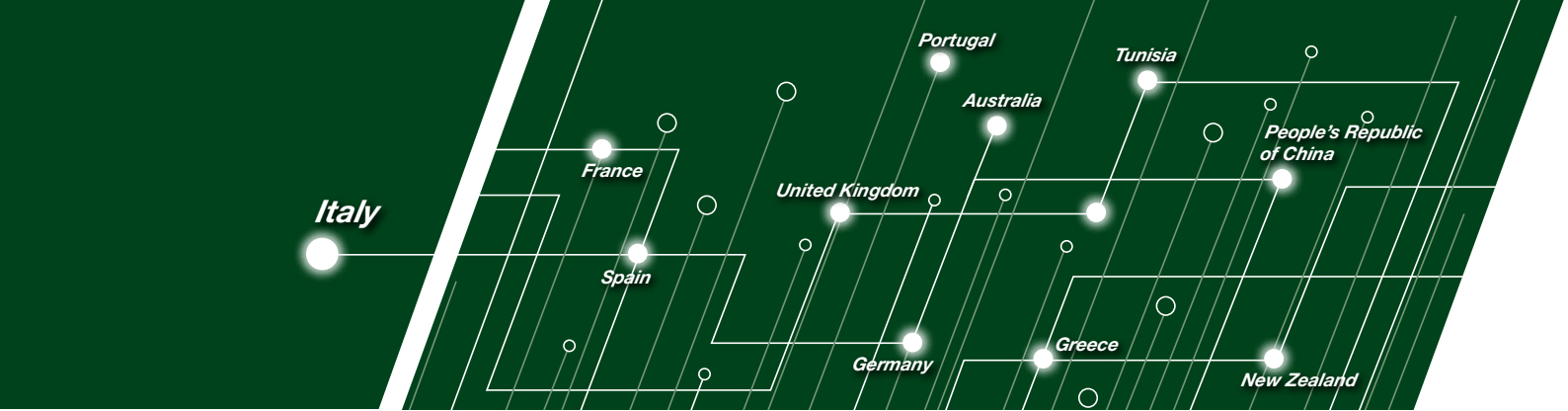

CAPRARI SPA Modena (Italy) • **CAPRARI FRANCE SARL** Maurepas - Paris (France) • **BOMBAS CAPRARI SA** Alcalá de Henares Madrid (Spain) • **CAPRARI PUMPS (U.K.) LTD** Peterborough (United Kingdom) • **CAPRARI PUMPEN GMBH** Fürth/Bayern (Germany) • **CAPRARI PORTUGAL LDA** Santarém (Portugal) • **CAPRARI PUMPS AUSTRALIA PTY LTD** Beverley SA (Australia) • **CAPRARI HELLAS SA** Thessaloniki (Greece) • **CAPRARI TUNISIE SA** Ben Arous (Tunisia) • **CAPRARI PUMPS (SHANGHAI) CO LTD** Shanghai (People's Republic of China) • **CAPRARI PUMPS NEW ZEALAND** Christchurch (New Zealand)



caprari
pumping power



www.caprari.com